

IMV DECK EXTENSION Installation Manual (provisional)

PART NUMBER: PZ475-N1270-00; -10; -20; -30; -40; -50

MANUAL REFERENCE NUMBER: AIM 000 497-2

- Preliminary operations:

- Scratch prevention

- Apply tape to the rear lamps lower area

- Apply tape in the area next to the hinges, both in the deck and the tailgate



- Preliminary operations:

- **Rear Bumper & Tailgate**

- Unplug rear license plate lights wiring harness clips & connectors;

- Break plastic strip;

- Unplug 3rd stop wiring harness connector;



- Preliminary operations:

- **Rear Bumper**

- Release the screws between arms and bumper (2+2 screws hexagonal head pneumatic tool needed)

- Remove bumper

- Remove bumper arms (remove 1+1 rear screws & release 1+1 front screws)



- Preliminary operations:

- Rear Lights

- Release screws (2x2 M6);

- Release clips (2x2 Clips);



- Preliminary operations:

- Rear Lights

- Unplug wiring harness;

- Remove carefully 2x clips (to be re-used);

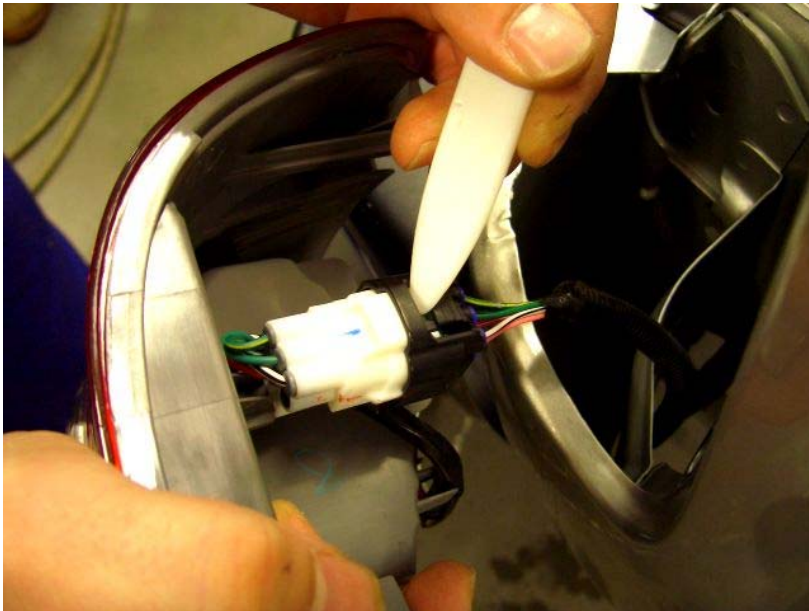

•Preliminary operations:

- Remove Stoppers (2x M6) and Strikers (2x2 M8).
- Release Hinge axis until screws faces the nut
- Release Retain Cables from tailgate
- Remove Tailgate
- Remove Retain Cables from the deck (2x M8)
- Clean Body areas to be glued



Installation Deck Extension Conversion Kit:

- Spacers
 - Mount Clips M6 to the deck (holes A and B). Use plastic tool to avoid paint damage;
 - Fix Spacers with 2x2 M6 (half rounded head, hexagon inside + washers);
 - Use original Clips in the Spacer (2x2);

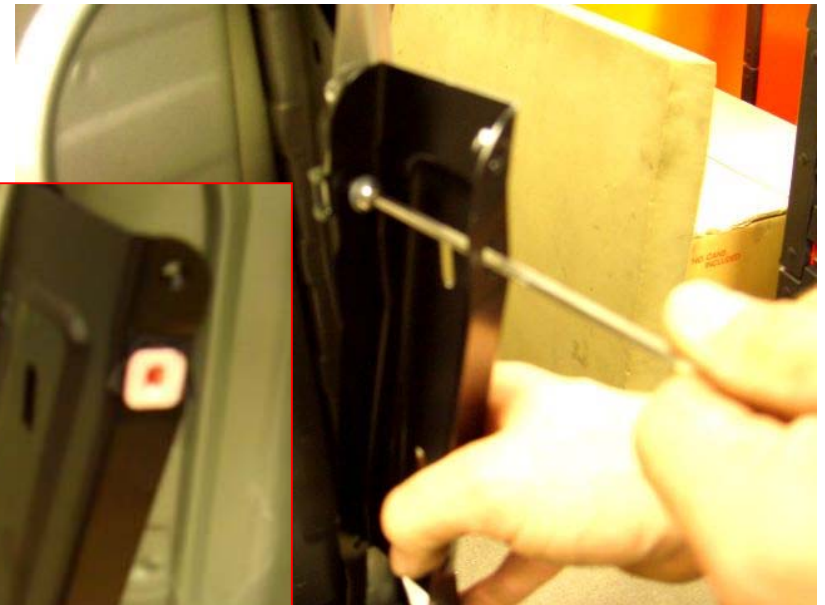

Installation Deck Extension Conversion Kit:

- Side Extension inner assemblies (RH+LH)
 - Use original Striker, Retainer and Hinge screws (2x4) to fix the part to the deck;
 - For all screws - Torque 12.5 Nm;
 - Fix part to the nominal position (vertically centered with the deck holes/ use special tool to position);



Installation Deck Extension Conversion Kit:

- Stopper, Striker & Retain cable
 - Stopper – use original screws and washers (2x1 M6)
 - Striker - use original screws (2x2 M8); Torque 19 Nm
 - Retain Cable - use original screw and washers (1x1 M8); Torque 27.0 Nm



Installation Deck Extension Conversion Kit:

- Side extension outer
 - Clip on the deck retainers (2x1) in lower area (face the Side extension outer to deck will help to identify proper position)
 - Adhesive rubber profiles starting from the top area



Installation Deck Extension Conversion Kit:

- Side extension outer
 - Pre-position part and adjust regulations, if necessary



Installation Deck Extension Conversion Kit:

- Side extension outer
 - Add clips in Side extension outer housing (2 for each side)
 - Apply adhesive to all areas parallel to the sealing profile and to the upper horizontal flange (see next page)



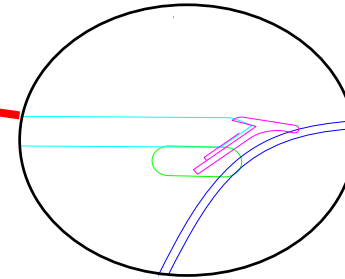
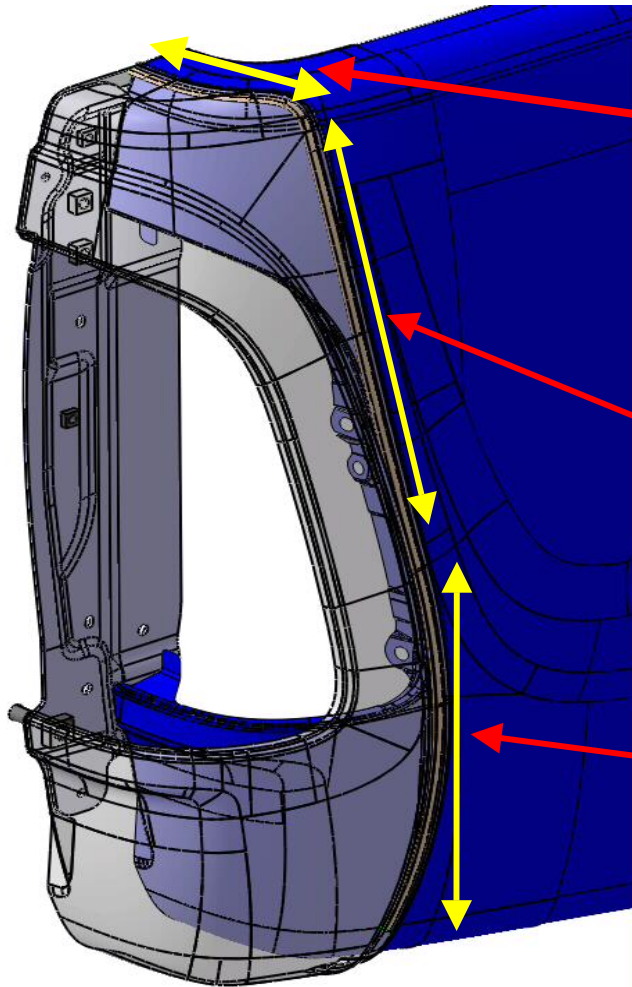

Glued to Side extension support

Distance 4 mm

(in order to absorb tolerances)

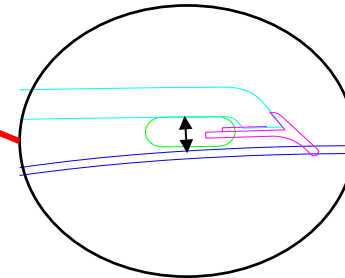

Glued to Side Panel Outer
Distance from 3.2 to 3.4 mm

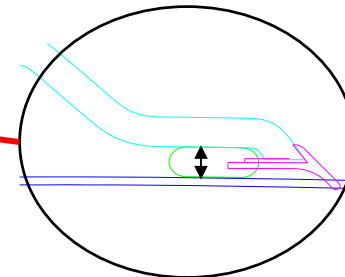

Glued to Side Panel Outer
Distance 3.1 mm



Installation Deck Extension Conversion Kit:

- Side extension outer
 - Fix with screws M6 rounded head to Spacer (2+2) (don't use washer)
 - Fix with screws M6 rounded head to Side extension inner assembly. Torque 5 Nm



Installation Deck Extension Conversion Kit:

- Side extension outer
 - Fix with screw w/washer tapping in lower area (1+1)



Installation Deck Extension Conversion Kit:

- Floor extension assembly
 - Apply bonding adhesive to the assembly – Floor extension & 3 Reinf.

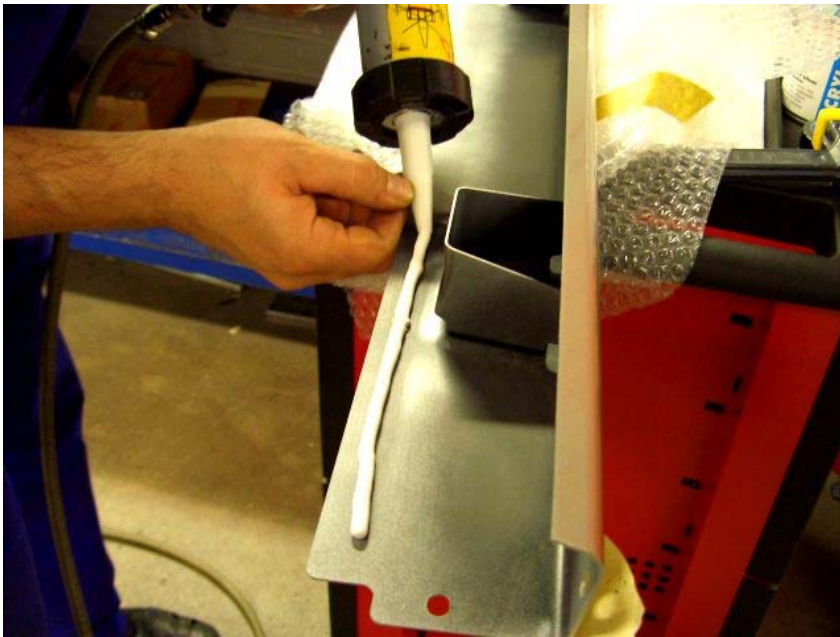

FLOOR EXTENSION



FLOOR EXTENSION REINFORCEMENT



Installation Deck Extension Conversion Kit:

- Floor extension assembly
 - Mount assembly to vehicle
 - Tighten 2x Screws



Installation Deck Extension Conversion Kit:

- Reinstall Tailgate
 - Fix the 2 Hinges by applying Torque 59 Nm
 - Remount Retain Cables



Installation Deck Extension Conversion Kit:

- Bumper
 - Install Bumper and tighten 2x2 bolts – Torque 45 Nm

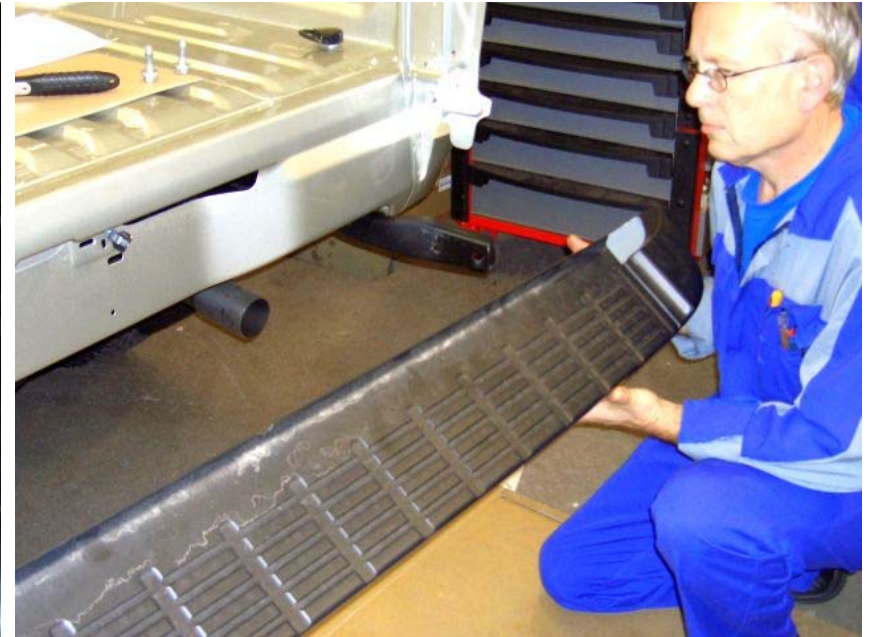

Functional tests

- Wire for plate illumination reinstalled in original position
- All rear lamp functions working
- Tailgate Stop Lamp working
- Licence plate illumination working
- Open-close tailgate to assure proper function

