



TOYOTA

Land Cruiser 120

N1 Conversion kit TNO

Installation instructions



Vehicle code: ** J120L - G * * * * W

Part number: PZ449-J0F21-00 7 - Seats with Aircondition / 7 seter med Aircondition





Weight: 56 kg

Manual reference number: AIM 001 141-1

Revision Record

Rev nr	Date	Page	Picture	Update	New	Deleted steps
1	14-1-08					

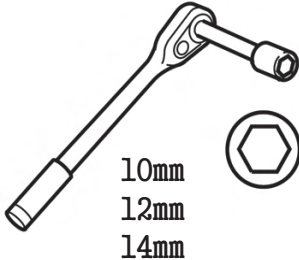
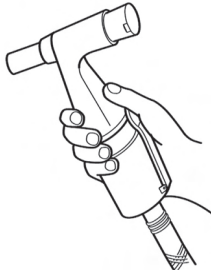
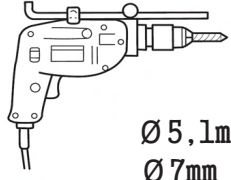
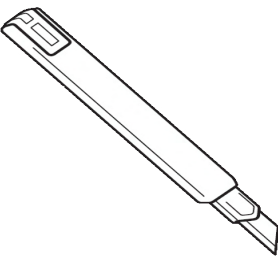
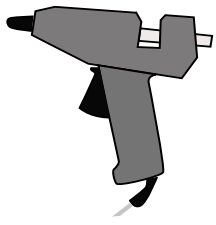
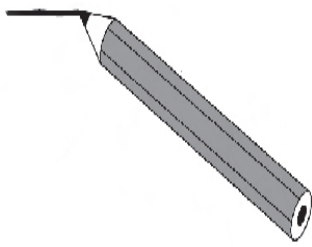
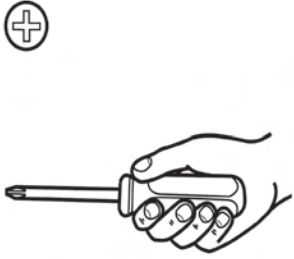
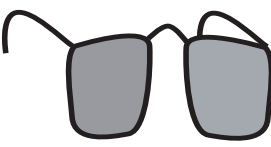







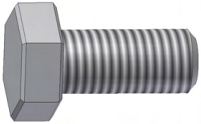

Tools

	 10mm 12mm 14mm		 Ø 5,1mm Ø 7mm
			
	 3M		

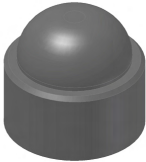
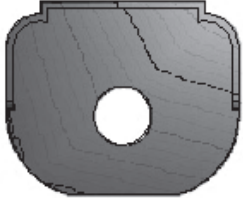

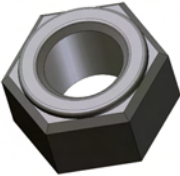
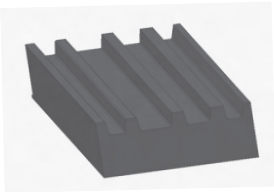
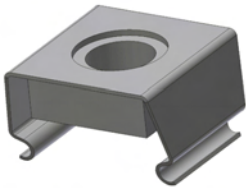

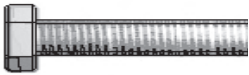



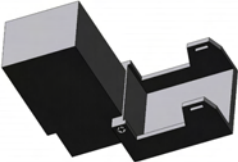

ITEM	QTY	Part number	Description
A	1	15000952	Floor support front
B	1	15000953	Floor support rear
C	1	15000831	Floor
D	1	15000846	Floor side cover leftv
E	1	15000847	Floor side cover right
F	1	05-88532	Hatch
G	1	15000834	Lower separator
H	1	15000840	Top separator
I	1	15000845	Handle bracket right
J	1	15000844	Handle bracket left
K	1	15000848	Roof lining
L	1	15000836	Full carpet floor
M	1	05-99525	Tube with cover
N	2	15000956	Foamed rubber spacer

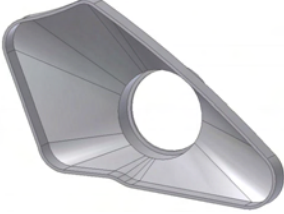
15000839 - Fitting kit

<p>A1 6x16 6K 2 PCS</p> 	<p>A2 6,4x15x1,5 20 PCS</p> 	<p>A3 5x14 NSS 16 PCS</p> 
<p>A4 500.13.203 4PCS</p> 	<p>A5 221 M06SW10G 8 PCS</p> 	<p>A6 500252 2 PCS</p> 
<p>A7 4,8x16 Splitt Bl 14 PCS</p> 	<p>A8 6 NMU 6PCS</p> 	
<p>B1 36.7210004 2,3 m</p> 	<p>B2 123-M06-2C ZC 4PCS</p> 	<p>B3 6x70 6K 2PCS</p> 
<p>B4 500250 2 PCS</p> 		<p>B6 4,2x16 FLS 2 PCS</p> 
<p>B7 6x40 6K 4PCS</p> 	<p>B8 5x10x16 NSS 37PCS</p> 	

15000954 - Fitting kit plastic covers

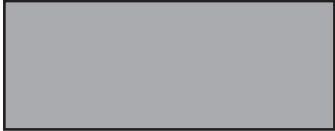
<p>D1 15000957 R c-column 1PCS</p> 	<p>D2 05-92062 2PCS</p> 	<p>D3 05-98722 3PCS</p> <div style="border: 1px solid black; padding: 5px;"> <p>OBS! Gardinairbag (CSA) er deaktiveret og må ikke aktiveres igen! Såfremt gardinairbag tilslutes kan dette medføre alvorlige ulykker. Toyota fraskriver sig ethvert ansvar i tilfælde af ulykker hvor gardinairbag (CSA) har været tilsluttet! Halv adskillelse: Venstre CSA deaktiveret. Hel adskillelse: Venstre og højre CSA deaktiveret.</p> </div>
<p>D4 21mm plugg 1PCS</p> 	<p>D5 05-99521 1 PCS</p> 	<p>D6 15000955 2 PCS</p> <div style="border: 2px solid black; padding: 10px; text-align: center;"> <p>Luft udtak er frakoblet</p> </div>
<p>D7 10905 4 PCS</p> 	<p>D8 15001092 L d-column 1 PCS</p> 	<p>D9 15000959 R d-column 1 PCS</p> 
<p>E1 15000958 L c-column 1PCS</p> 	<p>E2 042 0601 2PCS</p> 	<p>E3 05-91722 4PCS</p> 
Empty cell	Empty cell	Empty cell
Empty cell	Empty cell	Empty cell
Empty cell	Empty cell	Empty cell

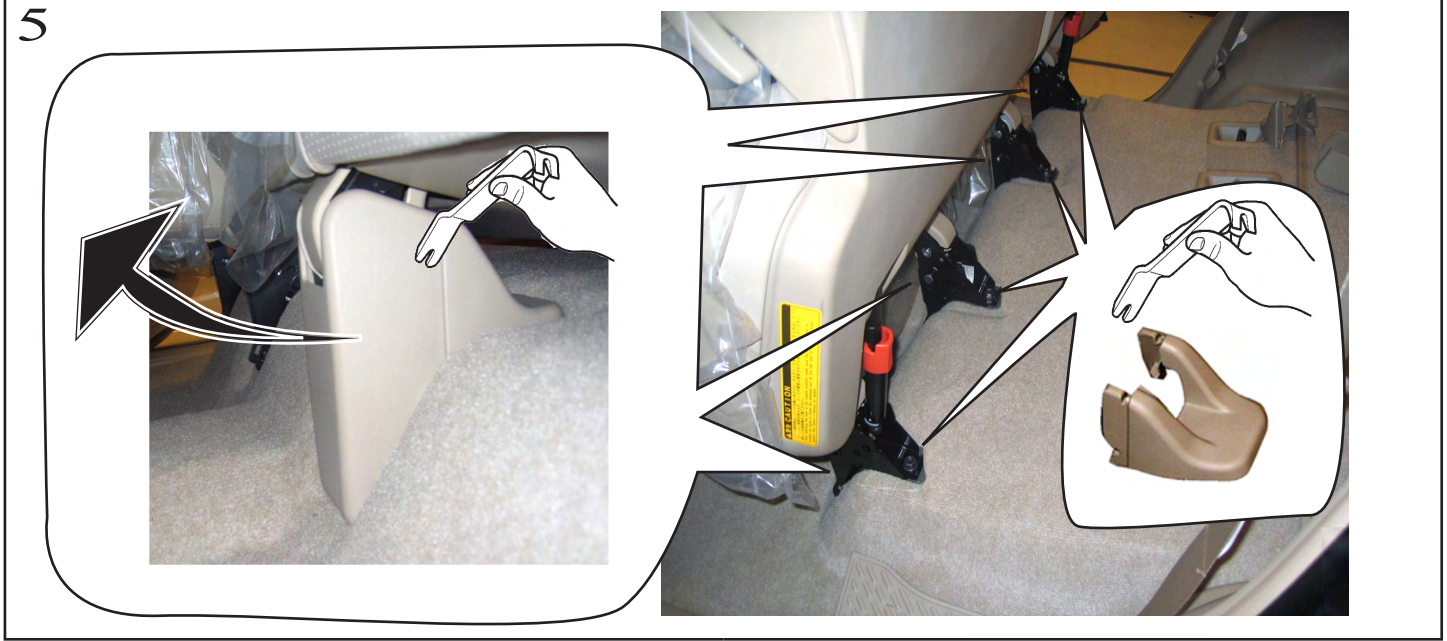
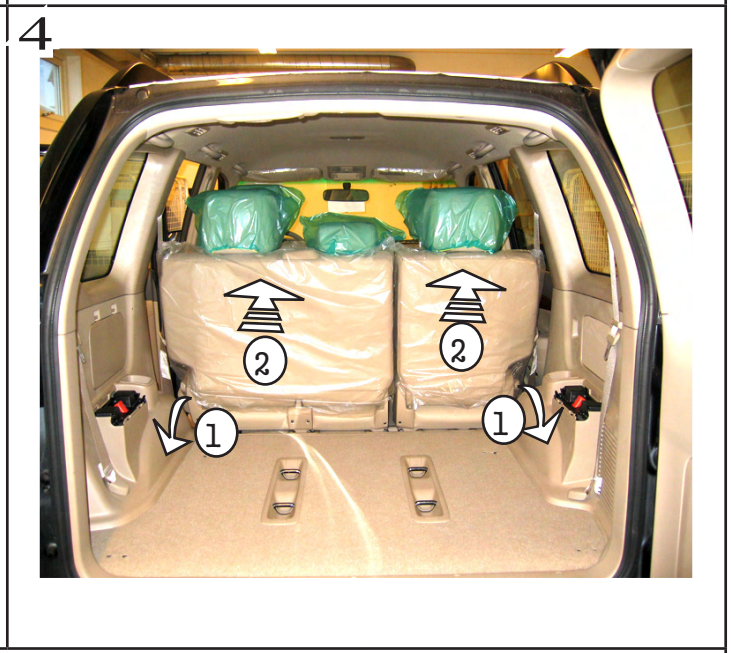
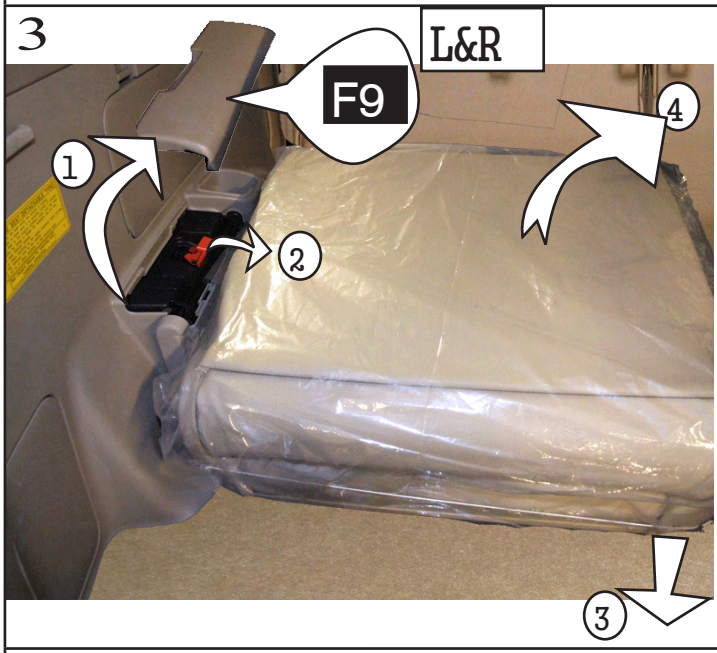
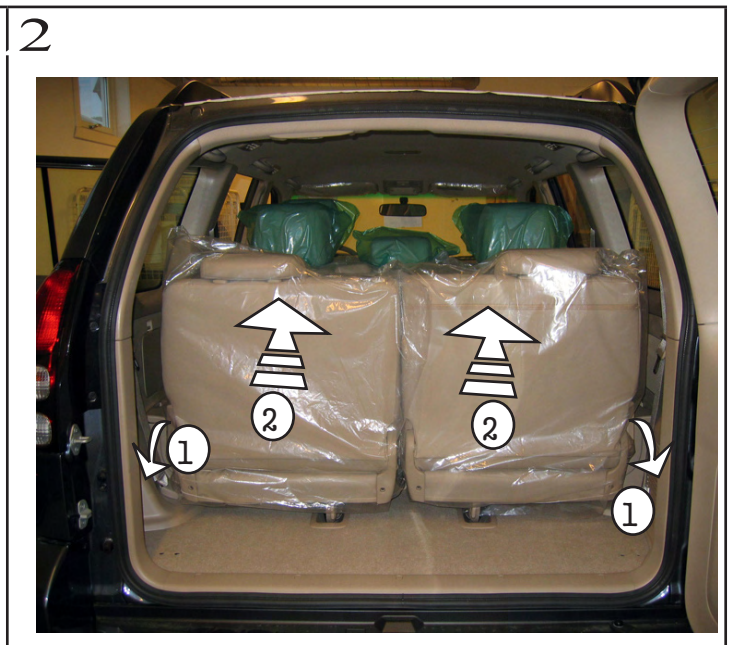
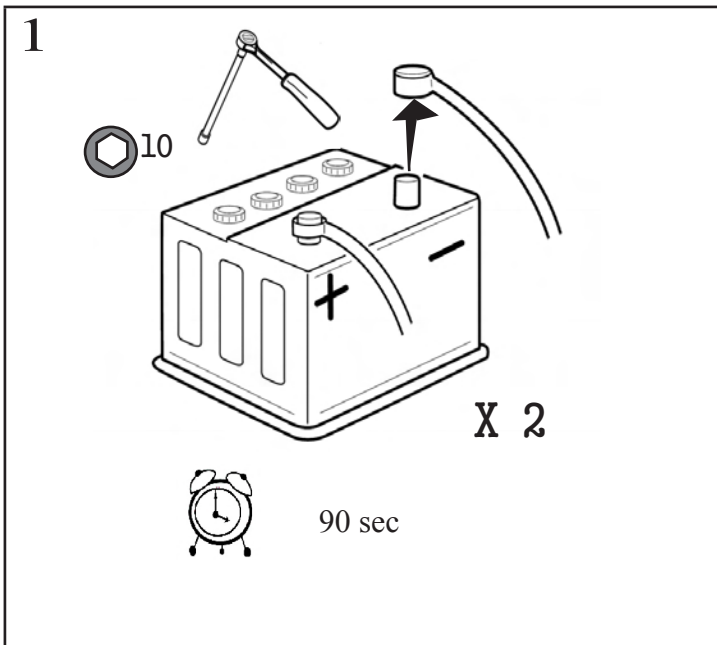

6

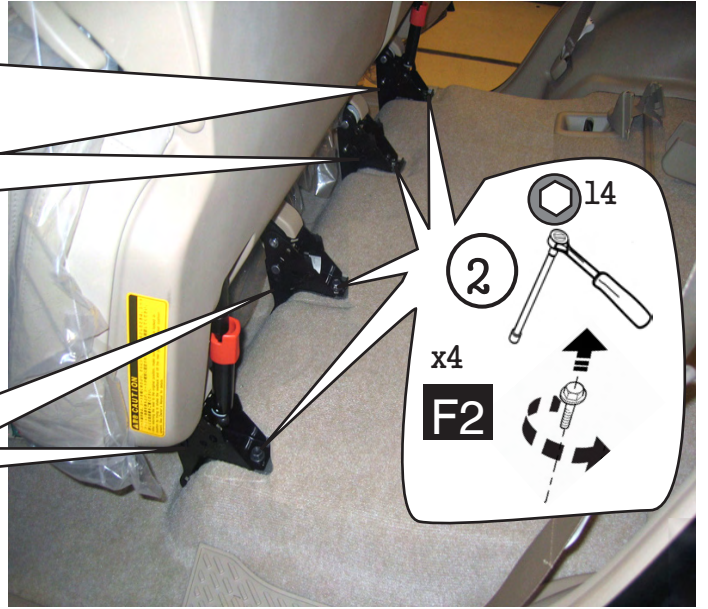
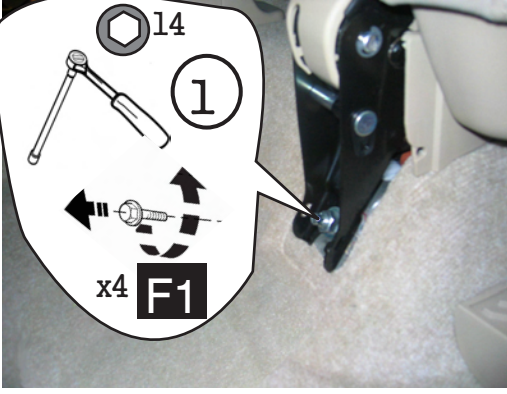

7

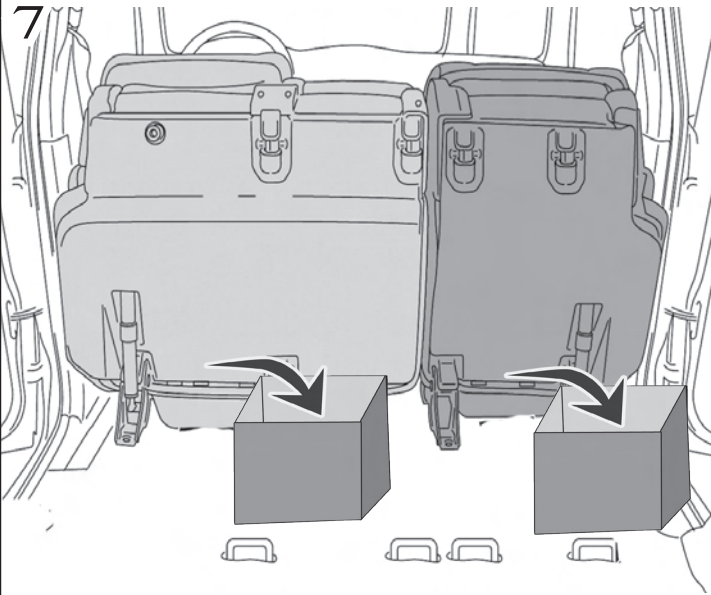

8

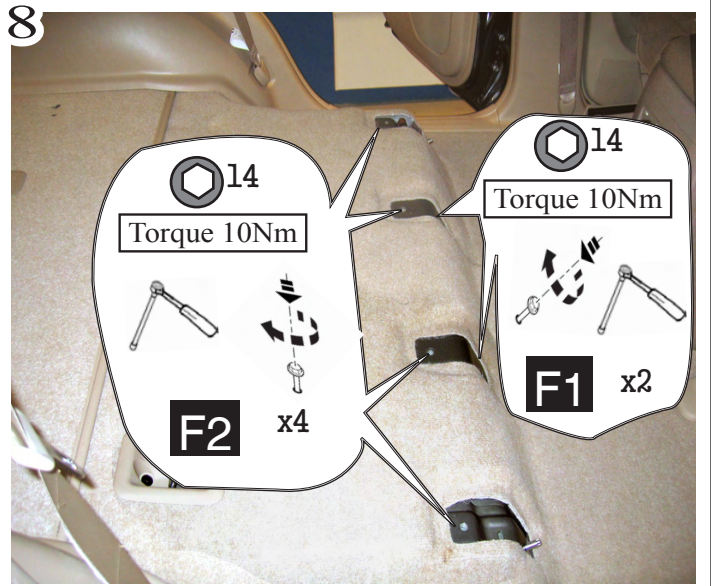

9

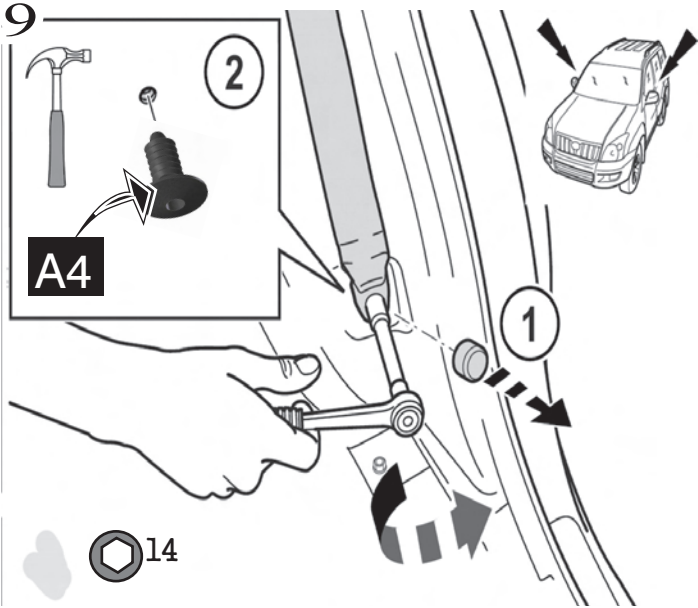

10

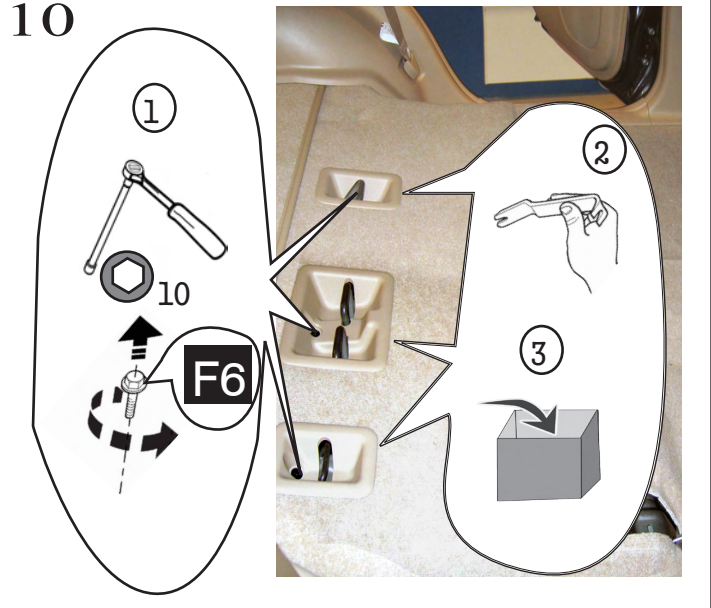

11

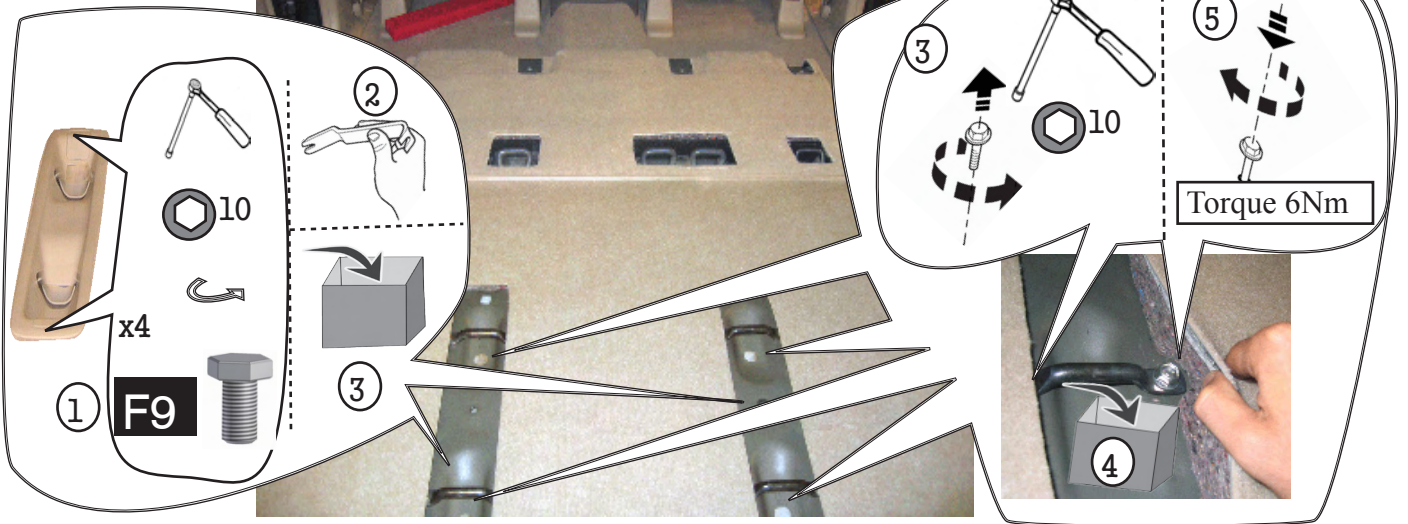

12

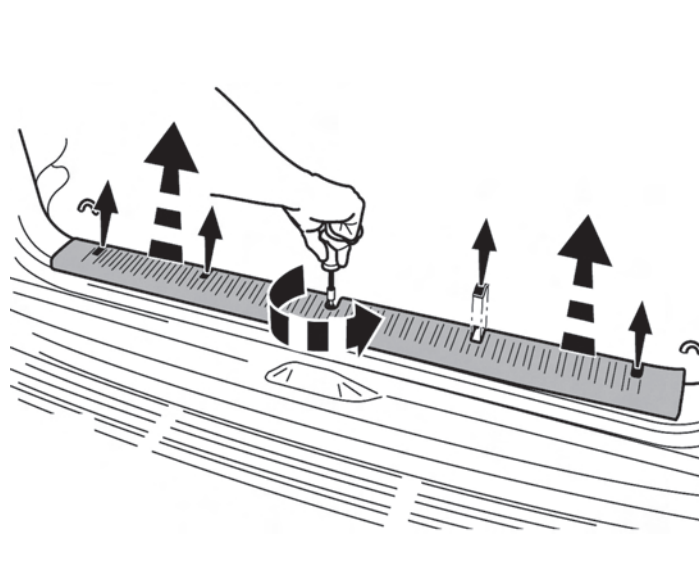

13

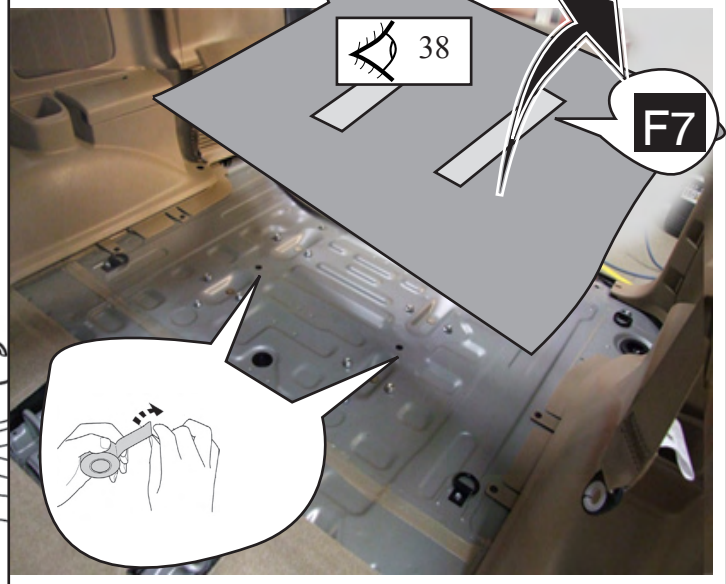

14

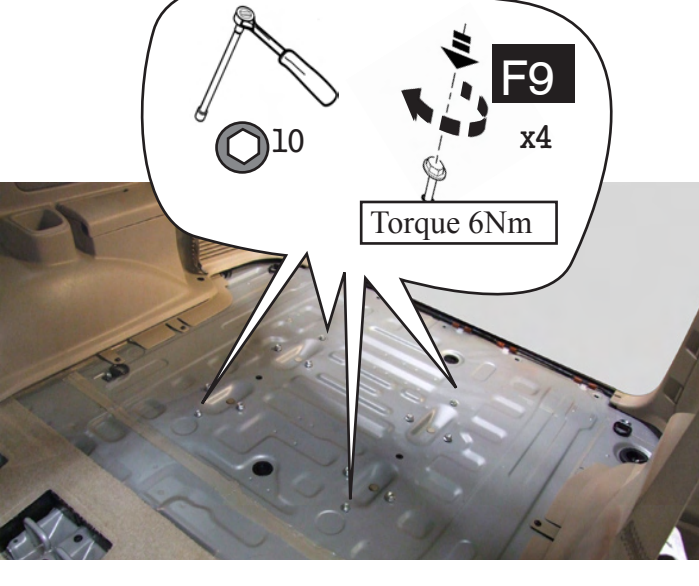

15

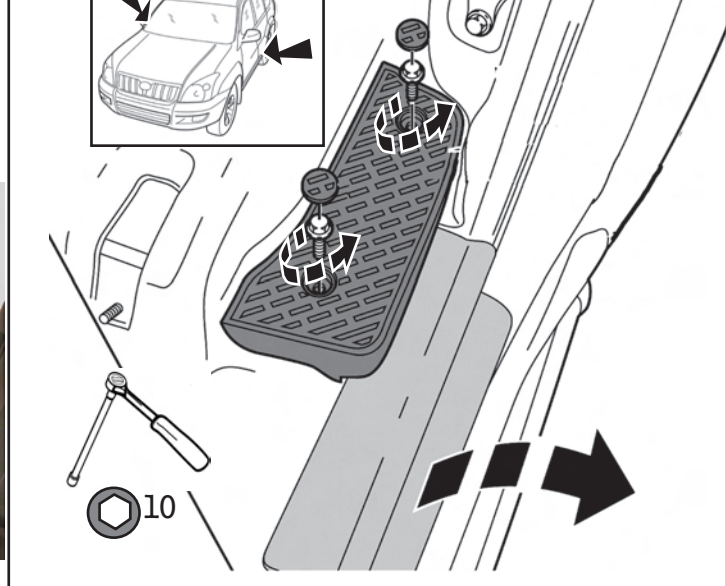

16

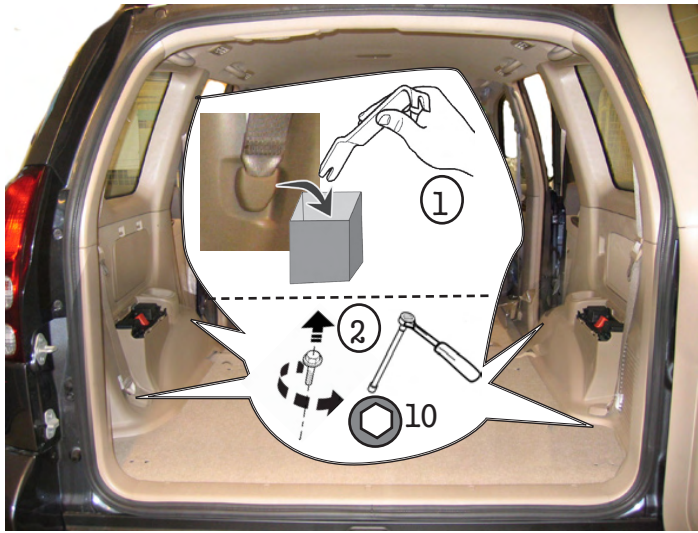

17

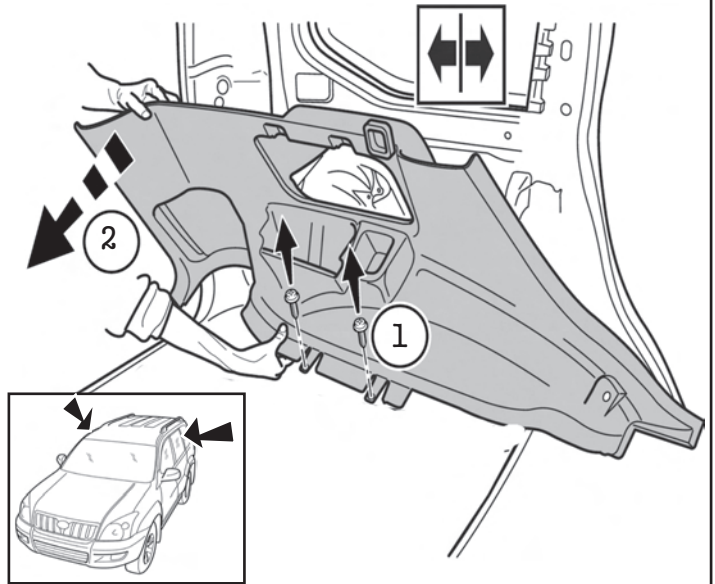

18

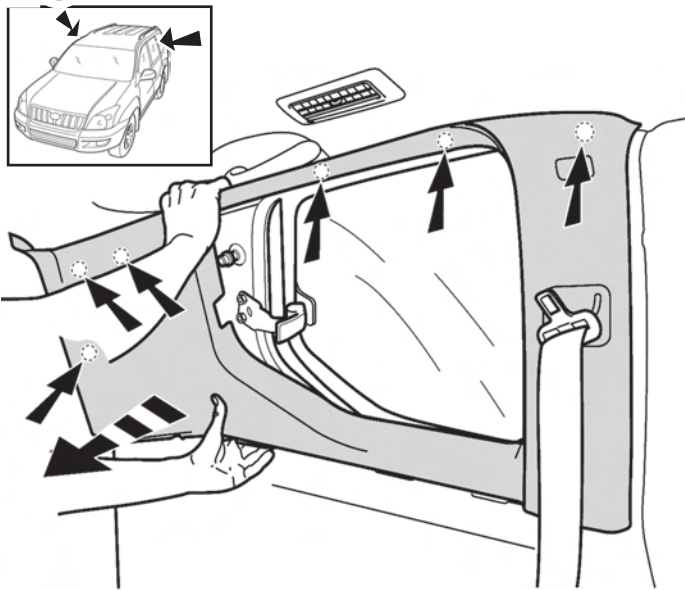

19

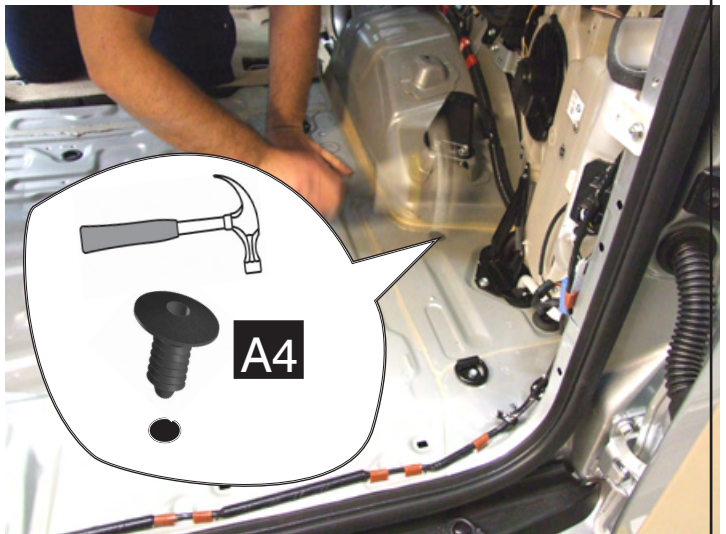

20

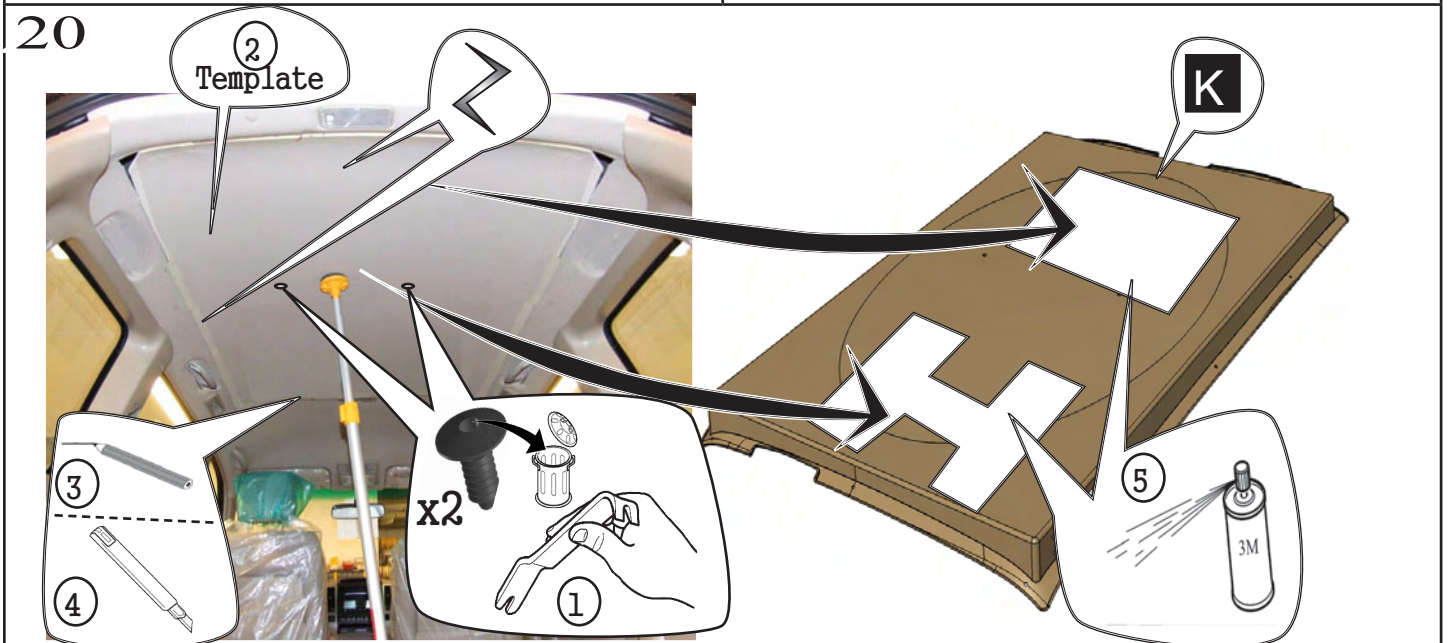

21

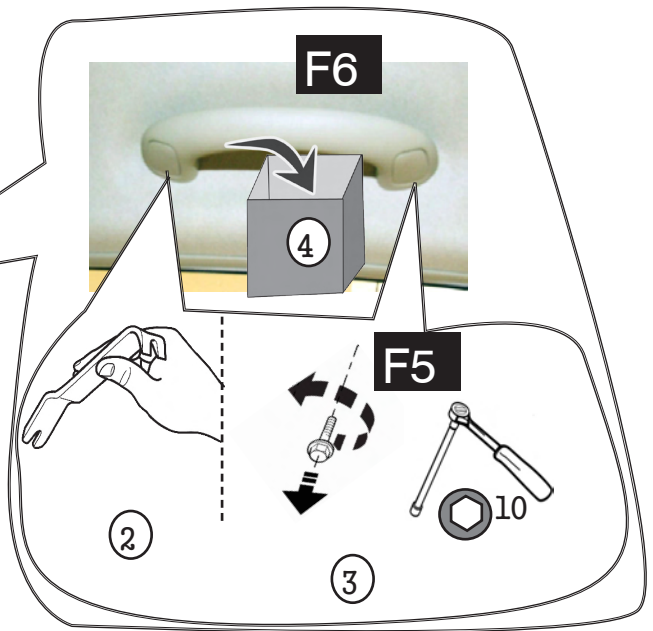

22

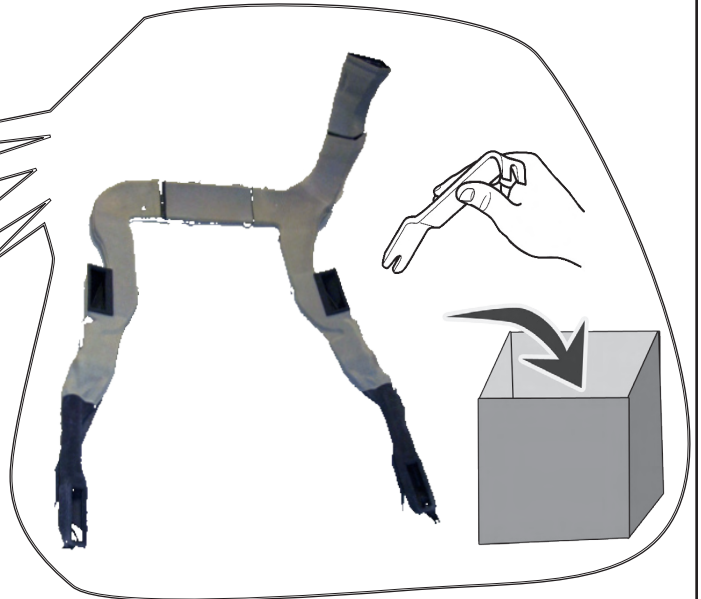

23

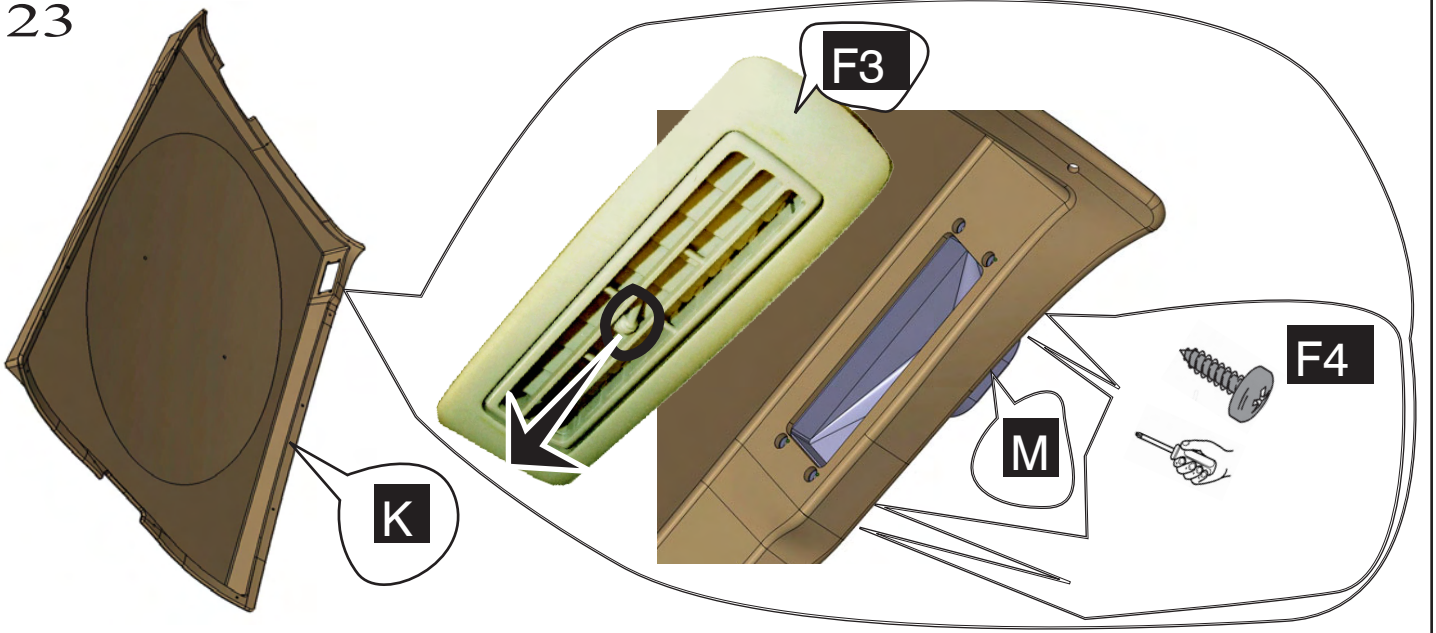

24

L&R

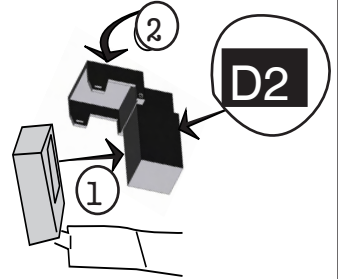
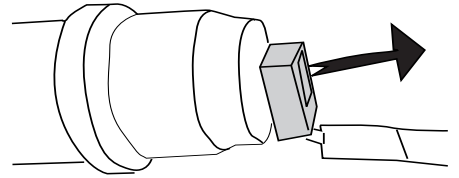

25

x2

1

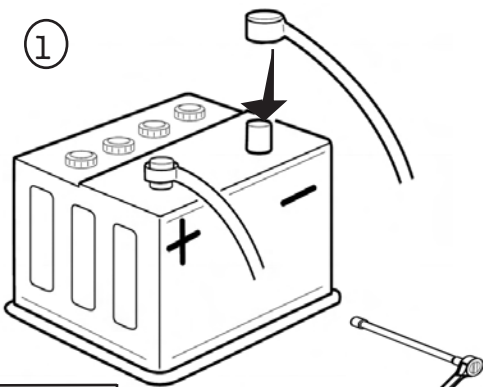

2



6 sec



Airbag + Roof lamps

Torque 6Nm



26

D3

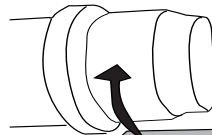

D3

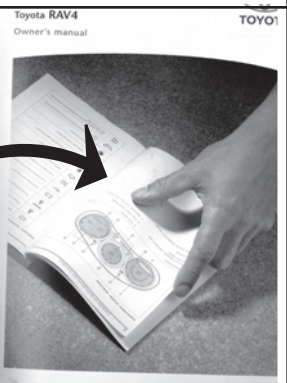
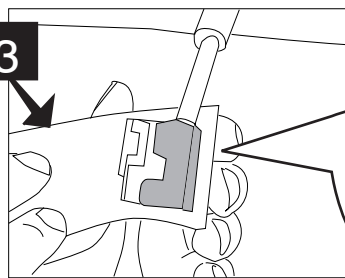

27

L&R

D3

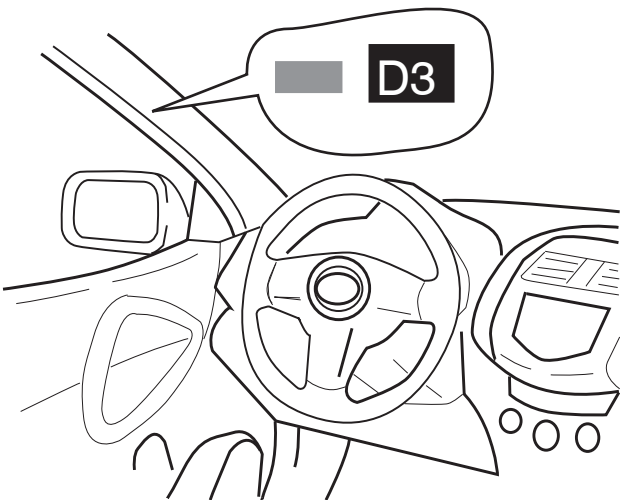

28

L&R

D3



D5



B6

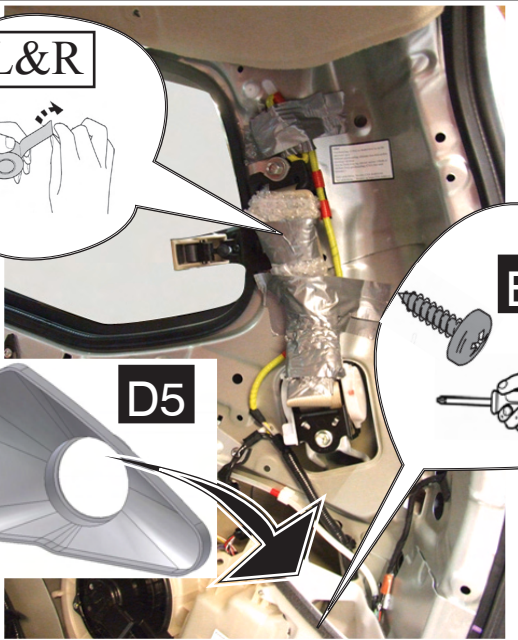
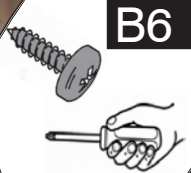

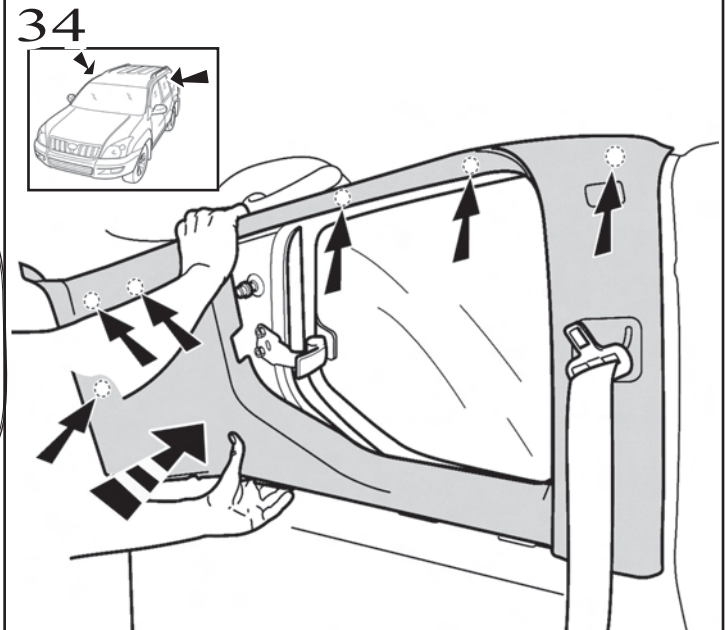
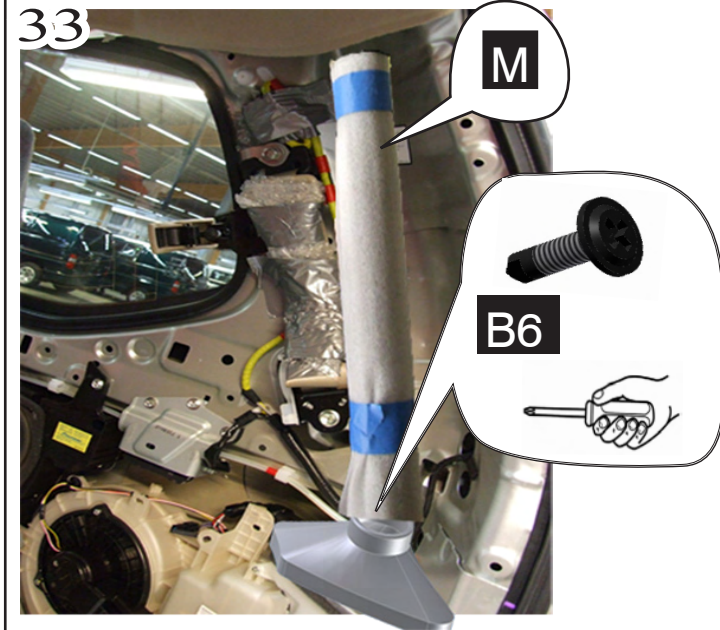
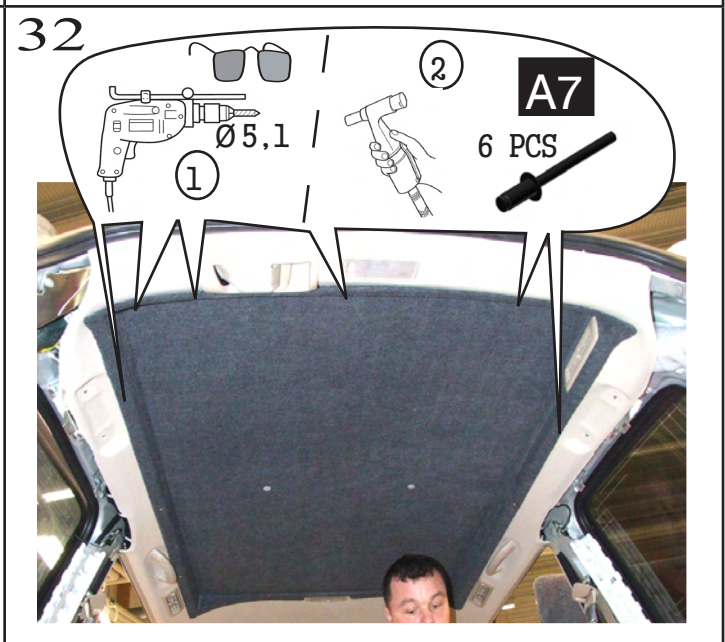
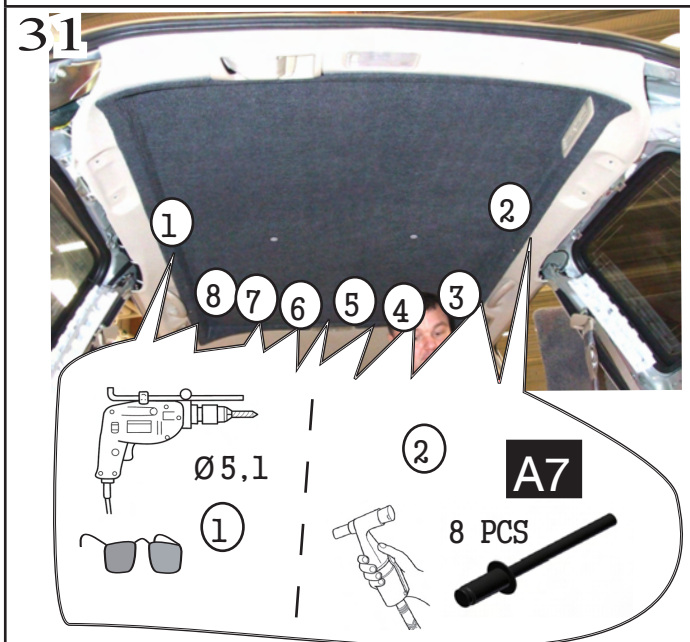
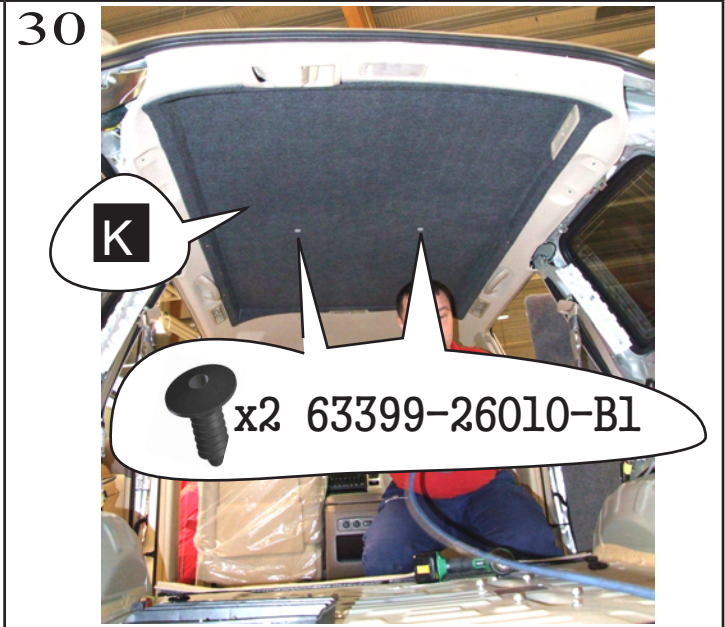
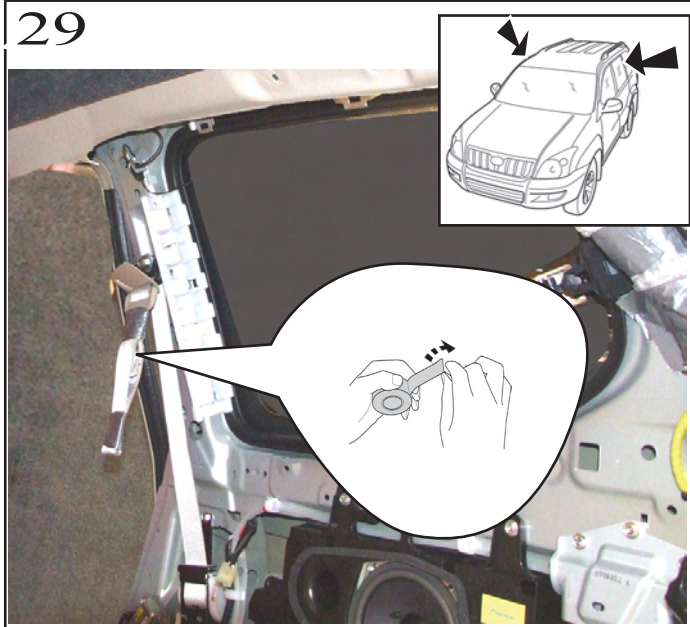

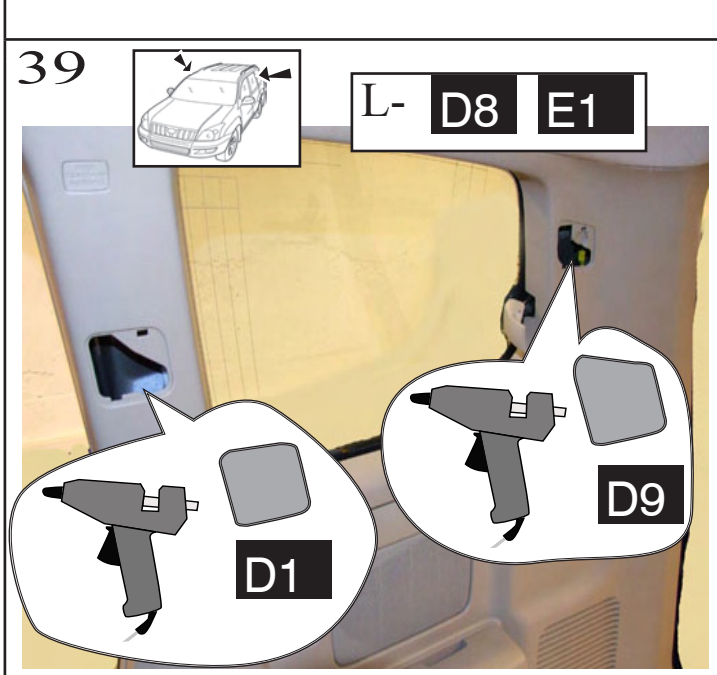
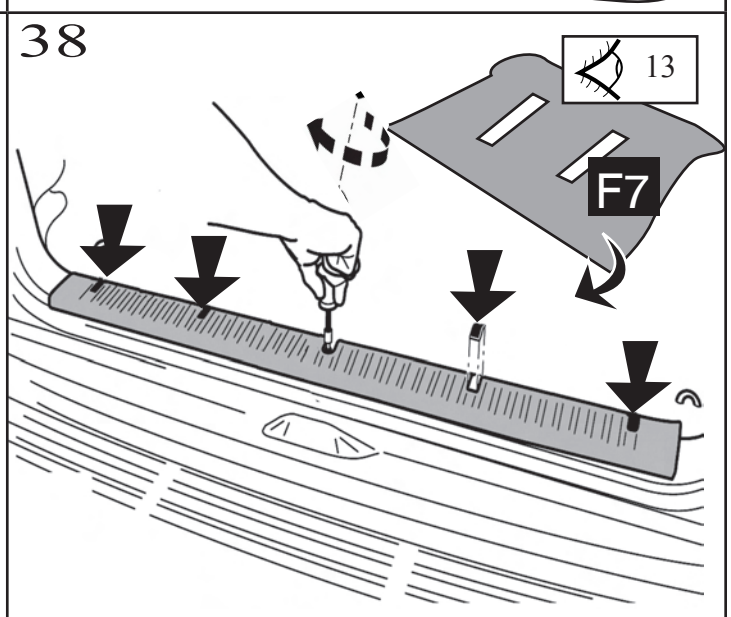
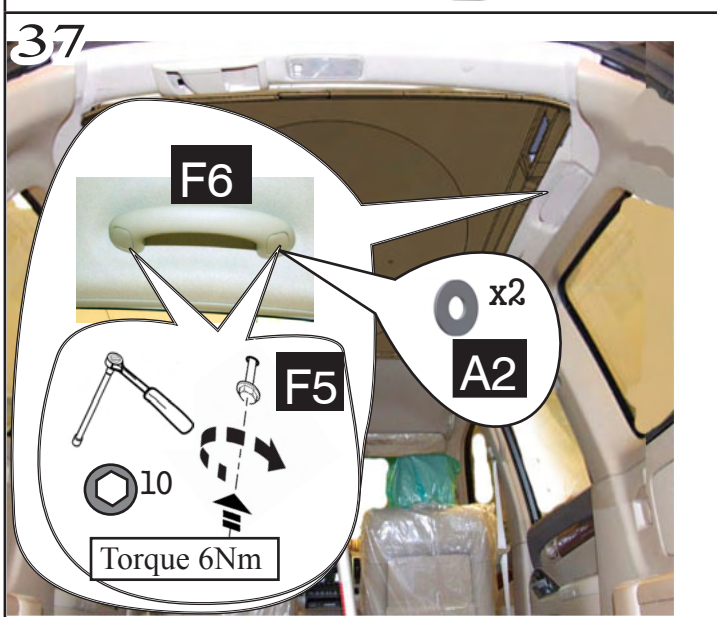
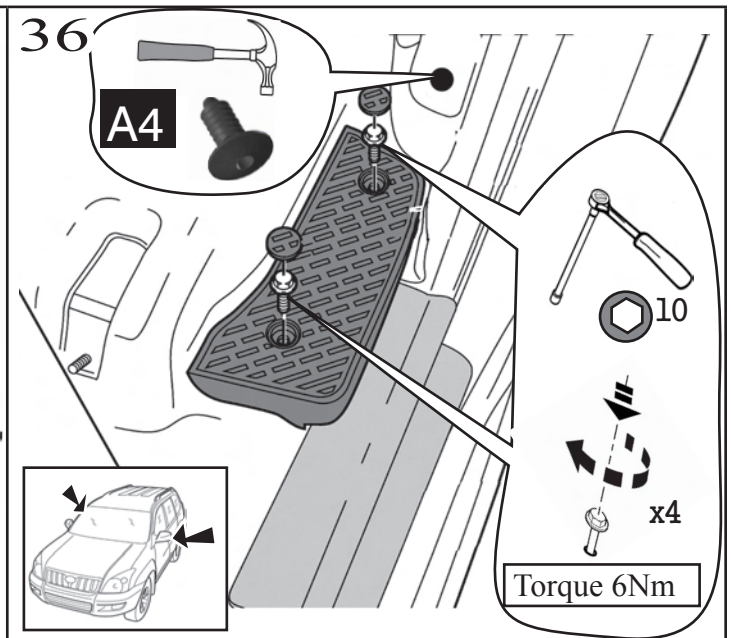
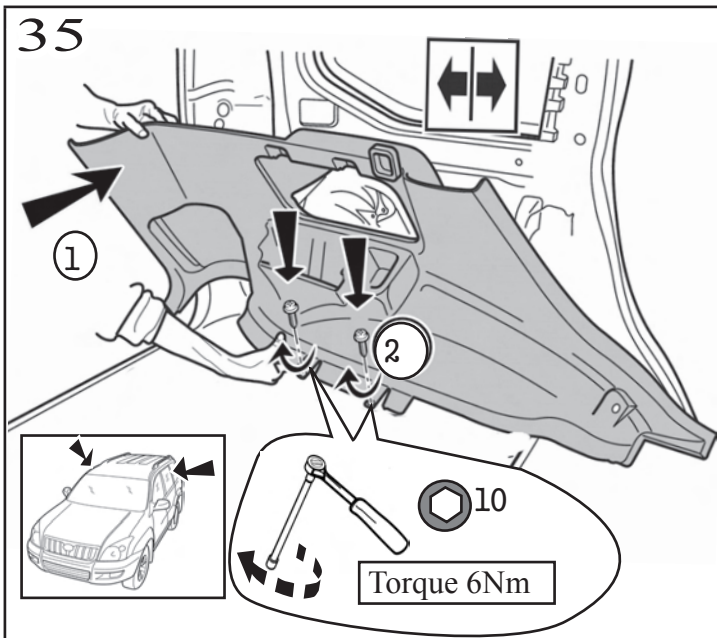

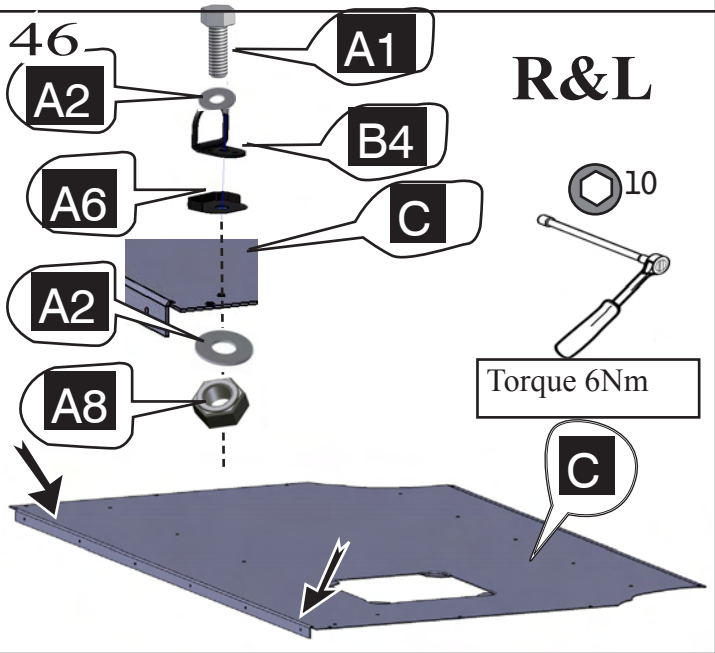
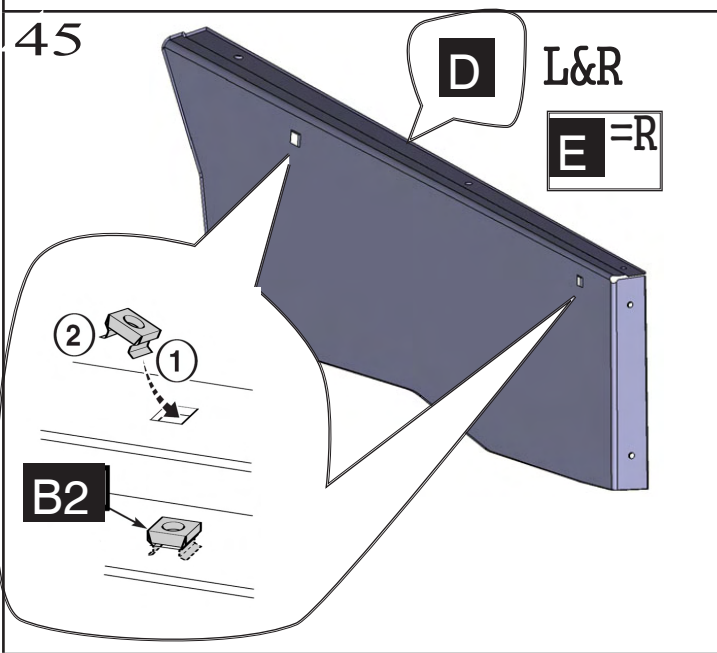
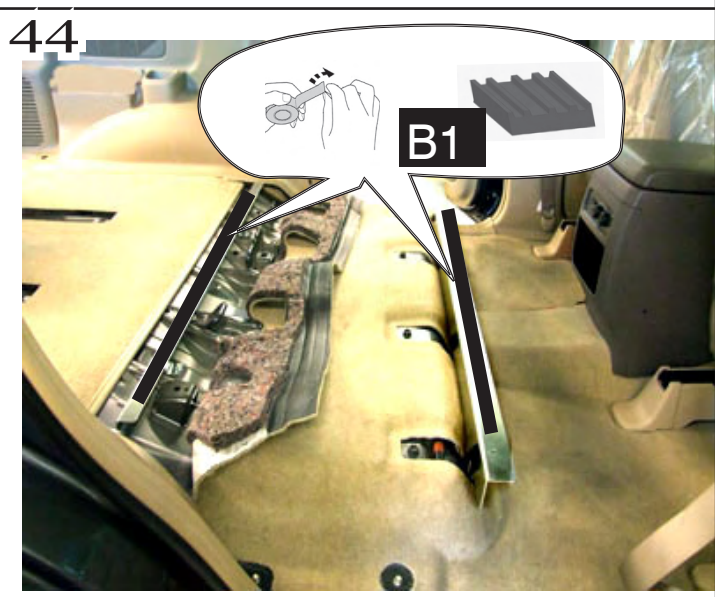
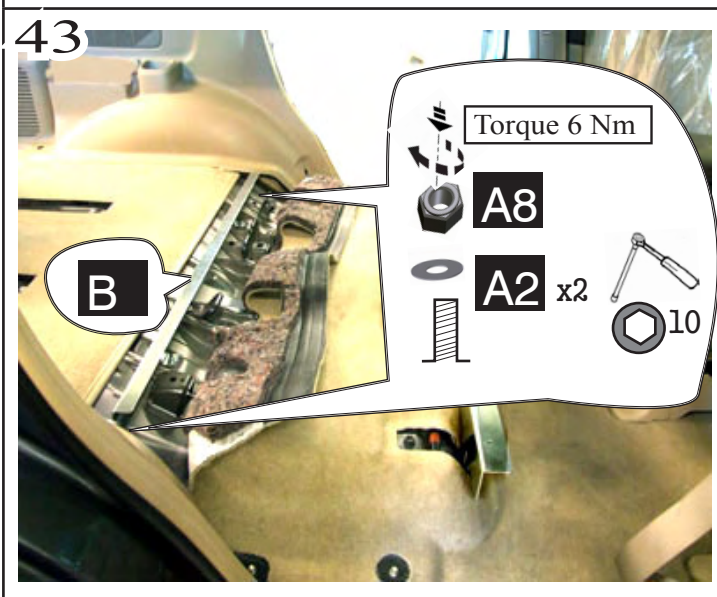
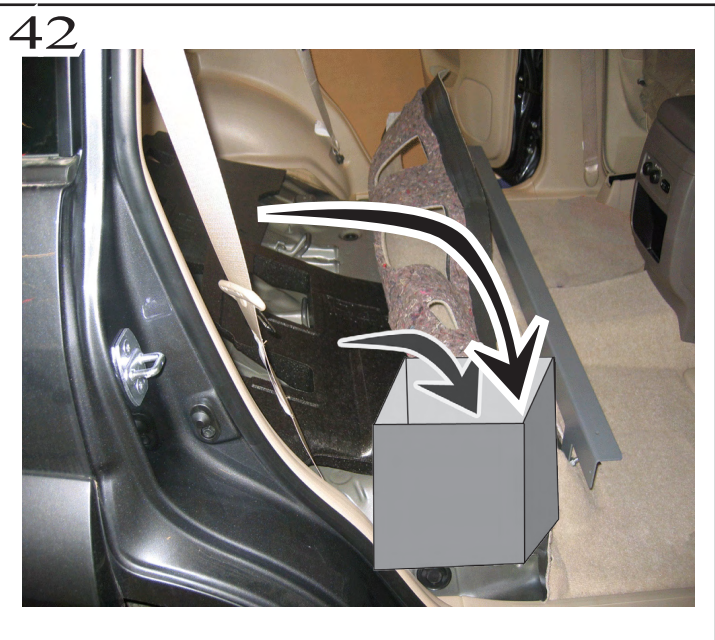
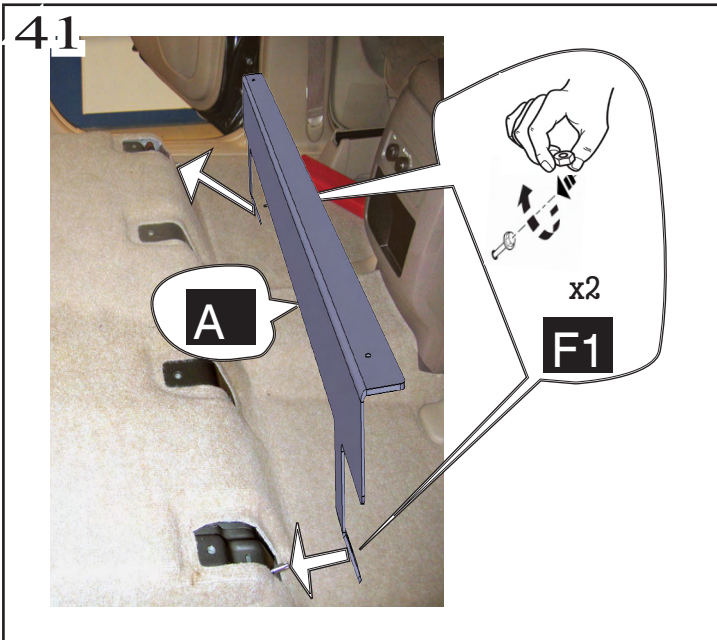

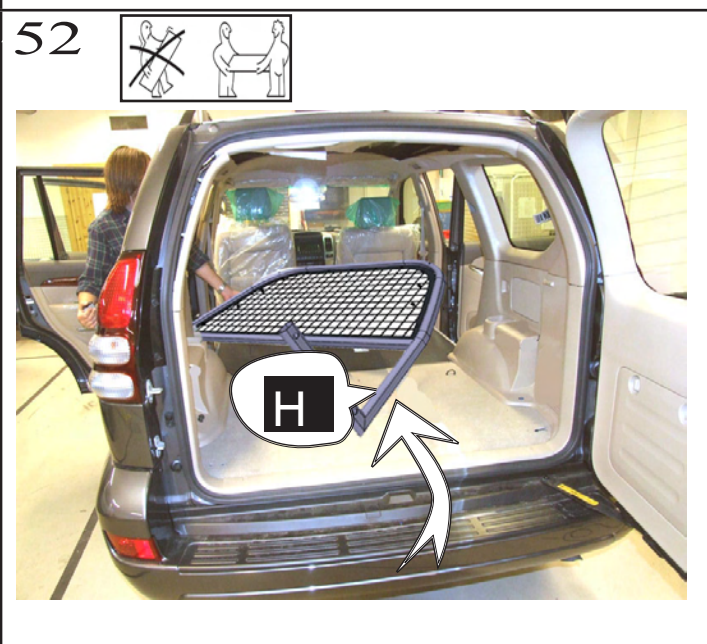
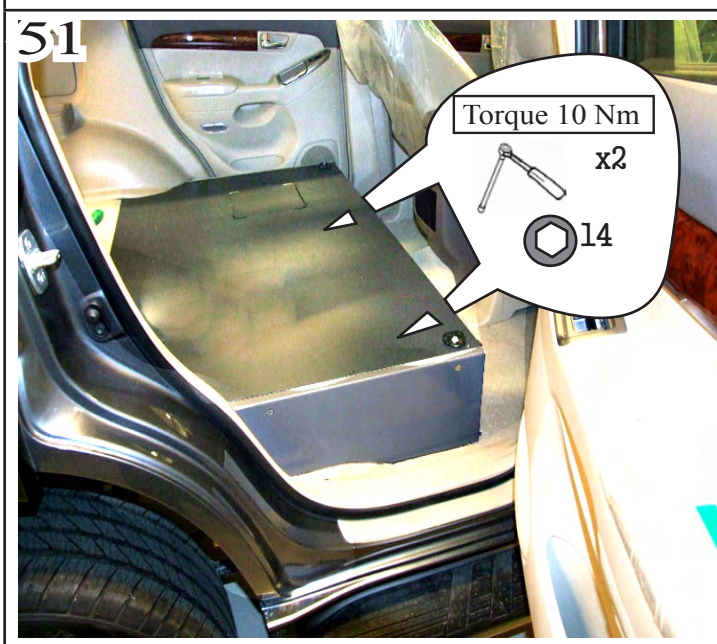
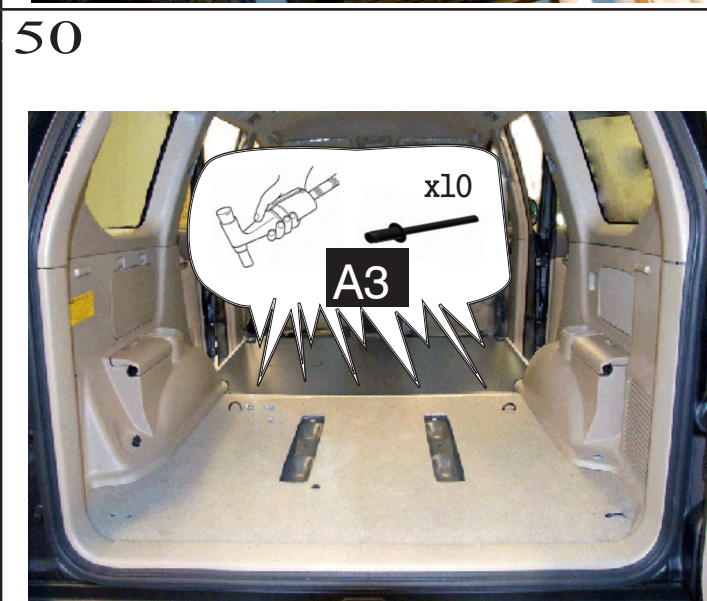
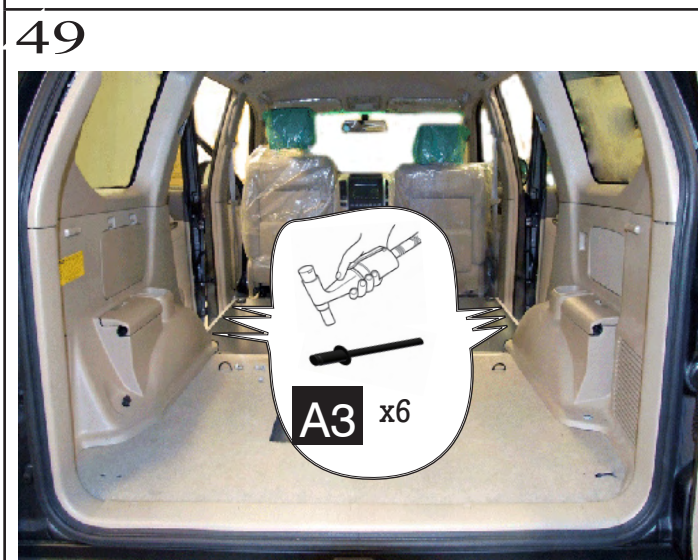
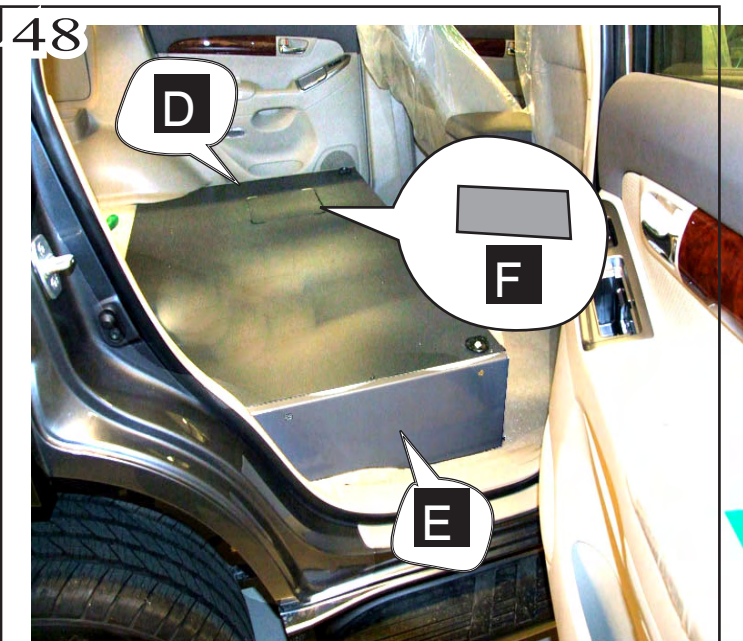
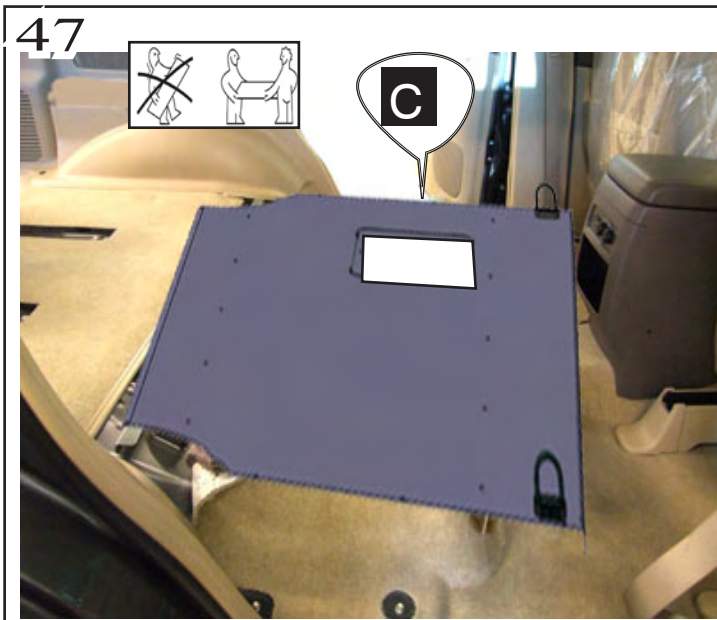

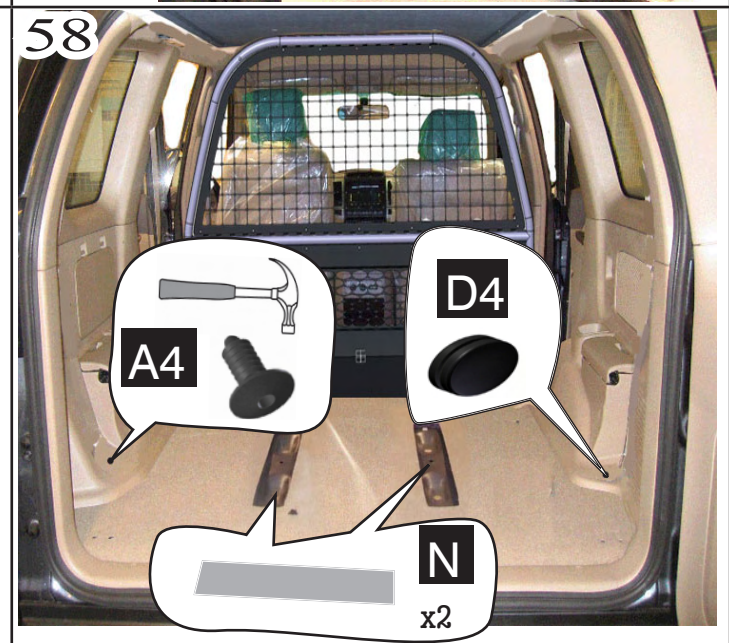
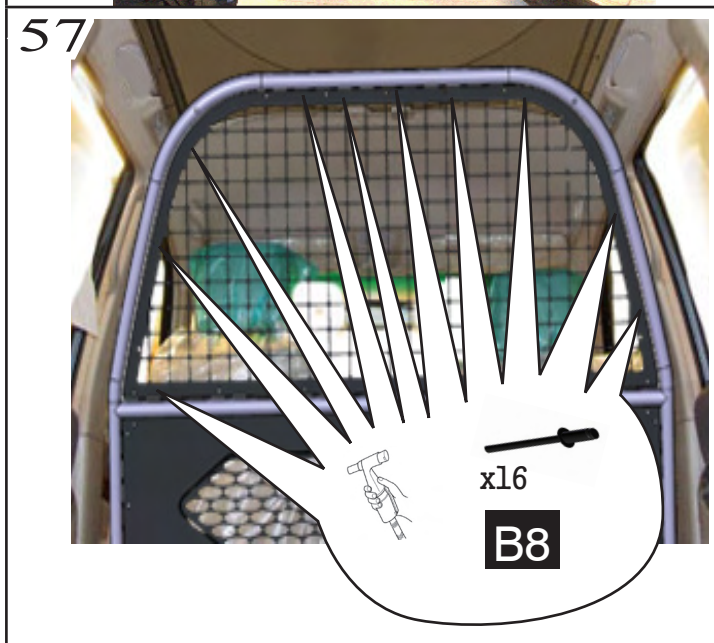
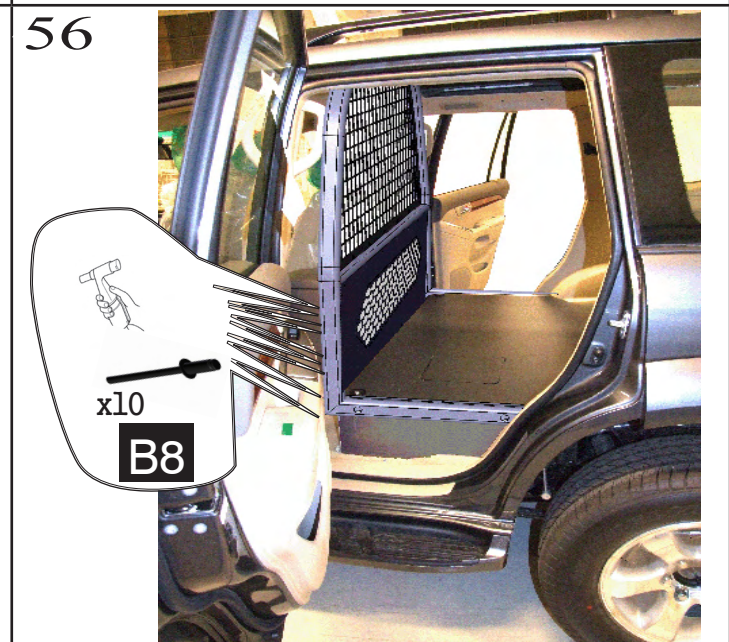
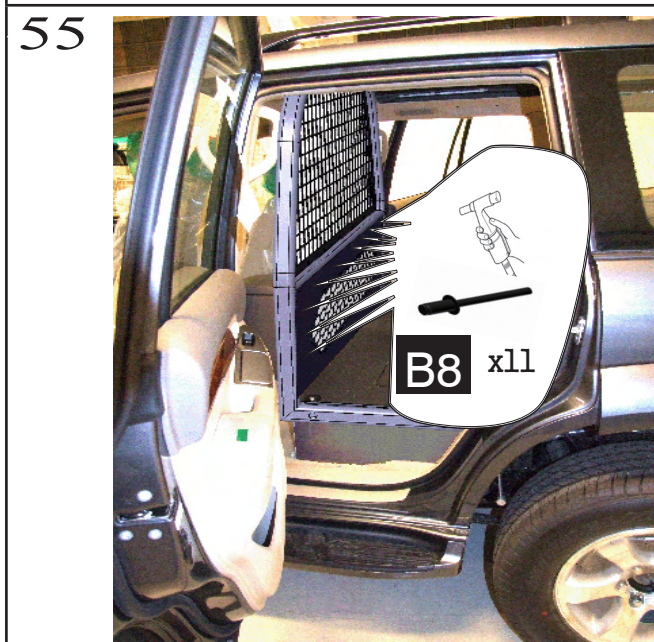
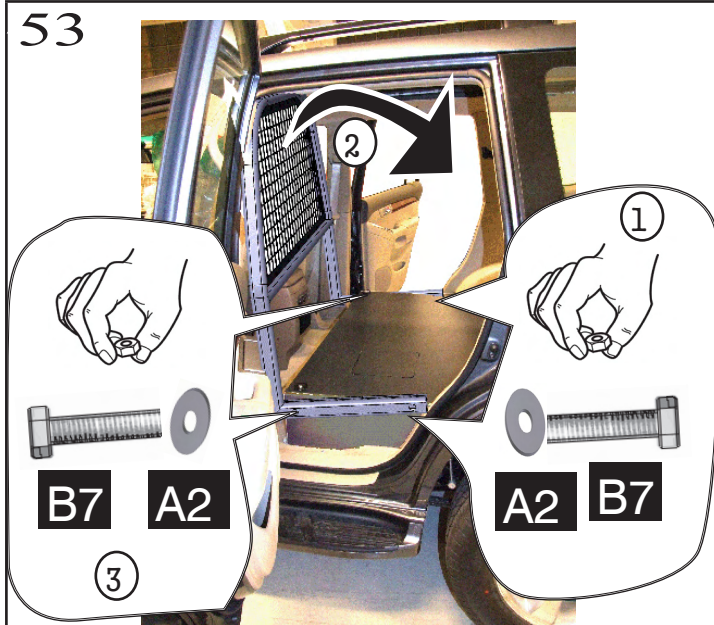

59

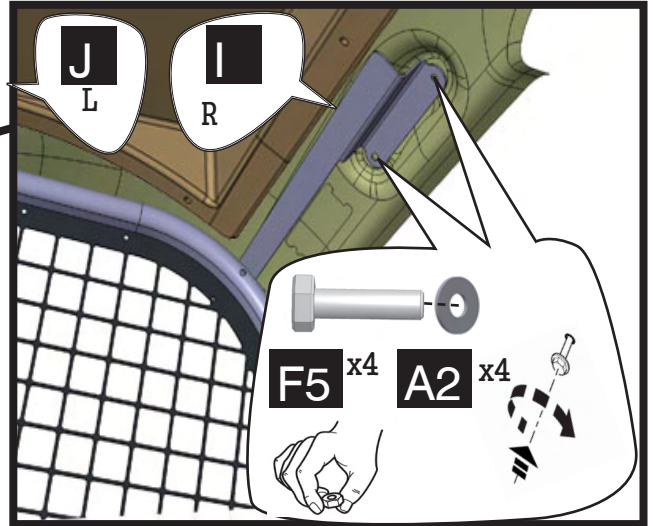

60

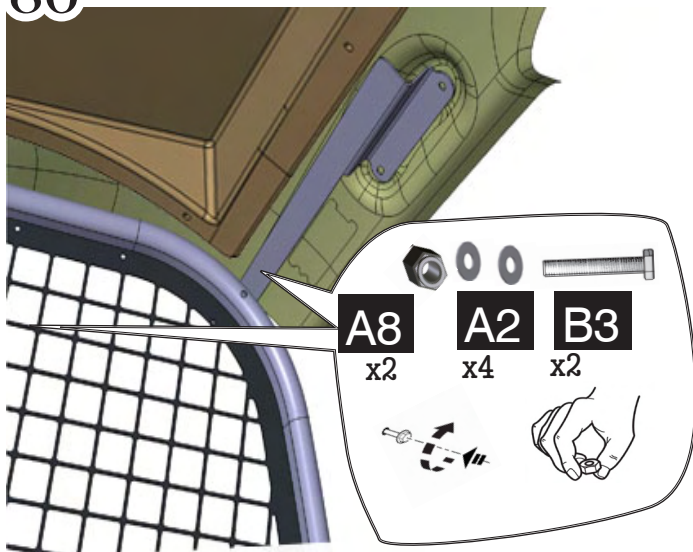

61

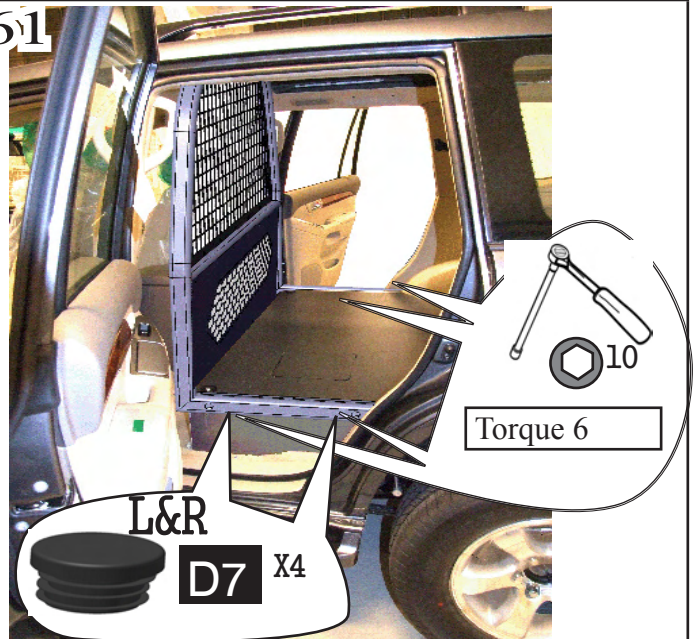

62

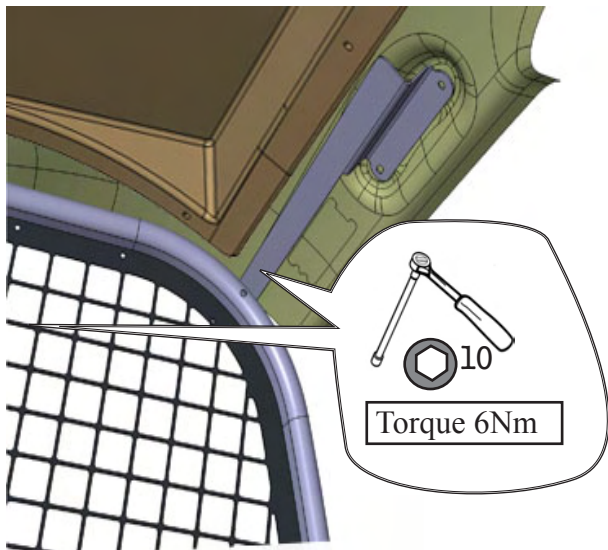

63

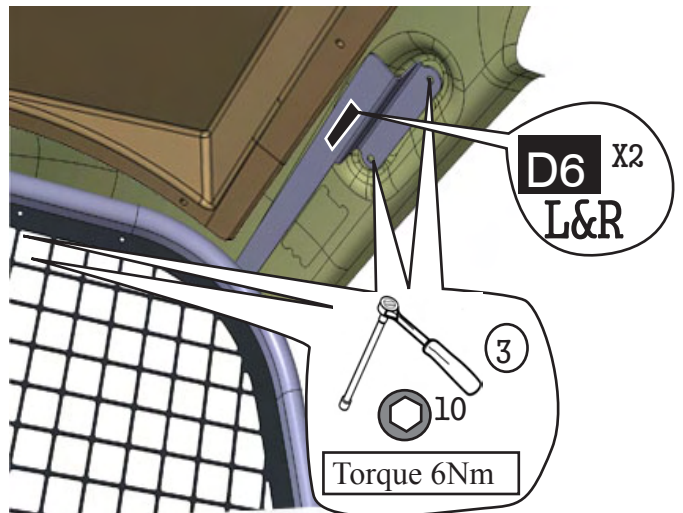

64

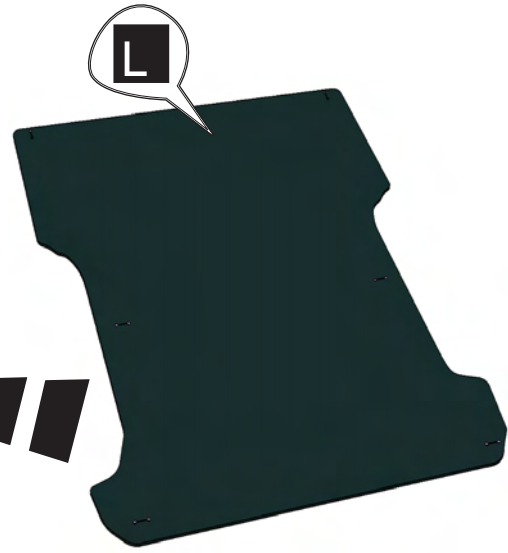

65

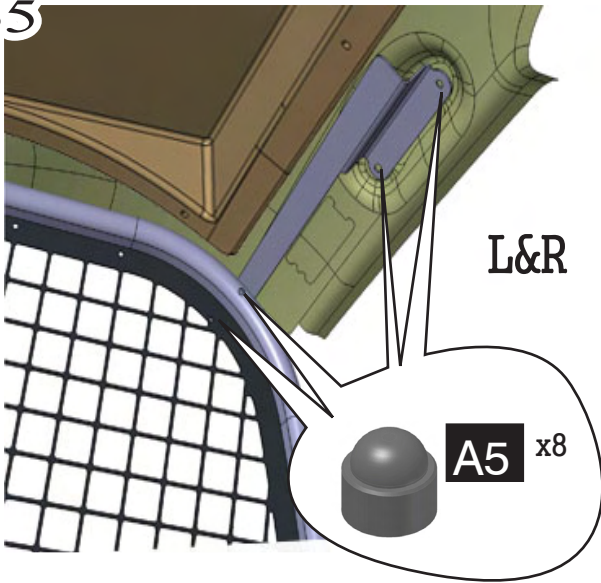

66

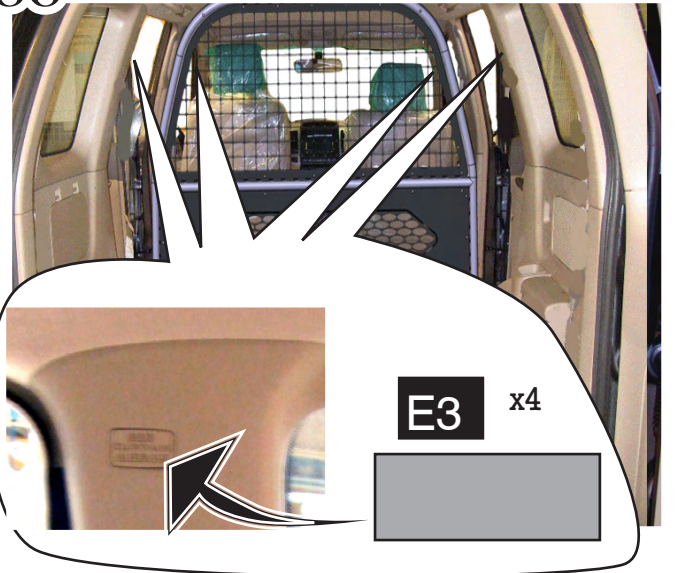

67

